

Display it like it is...

with RCA Display tubes.



Here are just five of the leading families in RCA's complete line of "advanced design" display and storage tubes that can meet your most exacting and specialized electro optics requirements:

1. Projection Kinescopes: Available in 3", 5", 6", and 7" diameters and a variety of power levels for both color and monochrome TV projection systems.

2. Ultra-High Resolution CRTs: Available in 5" and 7" diameters with ground optically-flat faceplates and ultra-fine grain phosphors for high quality photographic recording applications, and computer output microfilm applications.

3. Direct-View Display Storage Tubes: Available in 5" and 10" diameters with high luminance for military and commercial aviation weather radar displays.

4. Silicon-Target Storage Tubes: Available in 1" and 1½" diameters for use in a variety of information-rate converters; in TV "Frame Freeze"; and narrow-band video communication.

5. Voltage Penetration CRTs: Available in 8½" x 11", 16" and 24" diameters with dual-color phosphors that change color and/or persistence as the anode voltage is varied. Used for alphanumeric/graphic/computer terminals and special radar displays.

See your RCA Representative for more information on all the display tube families in RCA's comprehensive line. For your free copy of the new RCA Display Tube brochure, STC-900C, write Manager, Market Planning, Display Tube Products, Section ZD5, RCA, New Holland Avenue, Lancaster, Pa. 17604.

RCA Electro Optics

INTERNATIONAL SALES OFFICES: ARGENTINA—Casilla de Correo 4400, Buenos Aires/BRAZIL—Caixa Postal 8460, São Paulo/CANADA—21001 No. Service Rd., Ste. Anne de Bellevue, 810 Quebec/ENGLAND—Sunbury-on-Thames, Middlesex/HONG KONG—P.O. Box 112/MEXICO—Apartado 17-570, Mexico 17, D.F./SWITZERLAND—2-4 rue du Lièvre, 1227 Geneva.

Circle #7 on Readers Service Card

SID JOURNAL

The Official Journal of the Society For Information Display
Formerly INFORMATION DISPLAY JOURNAL

EX
Bernard J. Lechner
RCA Laboratories
Princeton, N.J. 08540

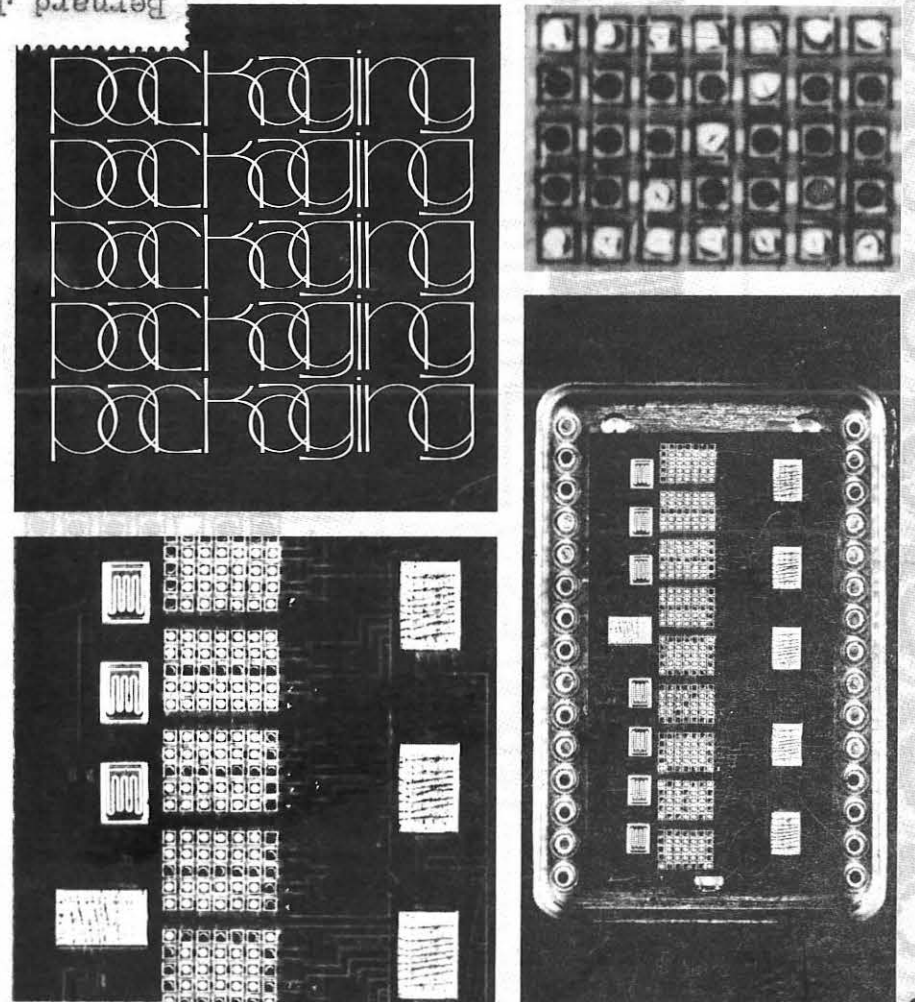

Packaging Solid State Displays

By Jack Norrie

Directory of Manufacturers of Light Emitting Diodes

Packaging of Multi-Character LED Modules With Self-Contained Driving Circuitry

By H. T. Groves

vol. 10, number 4

July/August - 1973



syntronic - yoke specialists

Complete Line for every Industrial & Military Display... in Production • Phone 312, 543-6444
Quantities... or Custom Designed to your specific requirement. TWX 910-651-2191



Selection of the proper yoke involves consideration of many interacting factors: the display system, the CRT, and the circuitry. To help you make the best choice for your application ask for free Yoke Selection and Application Check List.

SYNTRONIC INSTRUMENTS, INC.
100 Industrial Road, Addison, IL 60101
Phone: 312, 543-6444

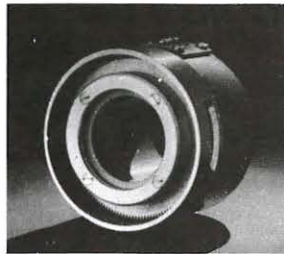

COMPACT ROTATING YOKES

Designed for Radar PPI's and other rotating applications. Up to 52° and 70° deflection angles. Versions available with d-c off-centering coils. Unit complete in aluminum housing with coil, slip rings and brush assembly, drive gear and bearing. Only 3 3/4" OD x 2 1/4" long; for 1 1/2" neck diameter tubes. For technical details request catalog page on Y25 series.



PRECISION STATOR YOKES FOR 1 1/2" TUBES

Designed for the high resolution required for character displays, time shared sweep displays, flying spot scanners etc. Laminated core provides exceptionally low astigmatism and only 0.05% residual magnetism. Push-pull or single-ended coils in a selection of impedances to match your circuit. For technical details request catalog page Y58 series.



HIGH-Q DEFLECTION YOKES FOR 1 1/2" TUBES

Developed for high speed random positioning and alpha-numeric displays where fast settling and high stroke speeds are essential. The ferrite core virtually eliminates core time constant. Beam settling is less than 2 usec. Available with push-pull or single-ended coils in a variety of impedances to match transistor drives. For technical details see catalog page on Y68 series.

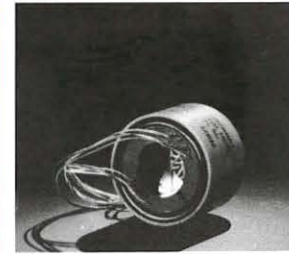

MINIATURE 1" ID ENCAPSULATED YOKES

Laminated core design ideal for small neck CRTs, airborne displays, small scan converters, flood gun storage tubes etc., in both single-ended and push-pull coil configurations. High efficiency. Wide range of impedances. Precise construction for close geometrical tolerances. Low residual magnetism. Fast recovery. Weight: only 7 oz. For technical details see catalog page on Y65 series.



MINIATURE FERRITE CORE YOKES

Close geometrical tolerances, high stroke speeds and fast settling for small alpha-numeric displays, random position displays, etc. are achieved with this 1" neck dia. ferrite core yoke. Push-pull and single-ended coils available in a wide range of impedances for transistor or vacuum tube circuits. For full technical details see catalog page C7400.

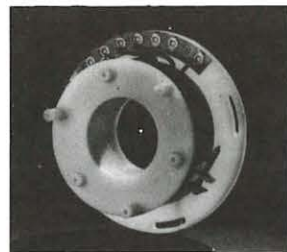

CHARACTER WRITING YOKES

Popular high-frequency "diddle" yokes provide low-cost method of producing alpha-numeric characters for computer readout displays. Mount directly on rear of Series Y58 and Series Y68 yokes which are used to position characters on CRT screen. For electrical and mechanical characteristics see catalog page on C5903/C5904 series.



SHIELDED PRECISION FOCUS COILS

Designed for precision applications where high resolution is required over the entire useful area of the CRT face. Static and dynamic coils combine into a single gap to ease alignment and positioning. Gap in forward location for superior focus and best image-to-object ratio. For technical details see catalog sheet on type F55 series.

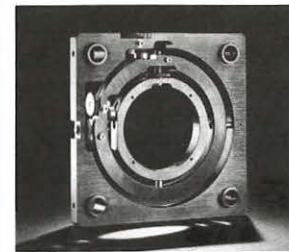

MICROPOSITIONER COIL/LENS ALIGNER

New low cost micropositioner for deflection yokes and focus coils or for optical bench applications provides minimum backlash fine adjustments for pitch, yaw, horizontal and vertical translation. Positive locks for all four independent adjustments make it easy to change one adjustment without disturbing others. Available from stock, Models D 7450 and D 7675.

SID JOURNAL

The Official Journal of the Society For Information Display

Packaging Solid State Displays	5	By Jack Norrie
Some of the newer techniques of packaging displays are described and the writer sets forth certain new packaging concepts, not yet used on production devices.		
Directory of Manufacturers of Light Emitting Diodes	9	
Packaging of Multi-Character LED Modules With Self-Contained Driving Circuitry	11	By H. T. Groves
By including driving circuitry in the same package with LED's, certain advantages are realized.		

1973 SID Cost Centers—Result of a Study	20	By E. A. Ulbrich
Honor Award Texts for Two Members of SID	22	

DEPARTMENTS

President's Message	4
SID Activities	23
New Products	25
Book Review	28
Letters	28
Sustaining Members	30
Advertisers Index	30

table of contents

CLOSING DATES: Editorial closing date is the first of the month preceding month of issue. Advertising closing date is the 15th of the month preceding date of issue.
SUBSCRIPTIONS: U.S., its territories and Canada \$7.50 per year. \$12.00 for 2 years. Foreign Countries \$15.00 per year.
EDITORIAL CONTRIBUTIONS: All material must be accompanied by stamped return envelopes. While all reasonable care will be taken with editorial submissions the publisher assumes no responsibility for art work, manuscripts or photographs.
Copyright 1972 by The Society for Information Display.
Controlled circulation postage paid at Los Angeles, California.

THE OFFICIAL JOURNAL OF THE SOCIETY FOR INFORMATION DISPLAY. Published bimonthly by Blackwint Publishing Company, 1605 Cahuenga Boulevard, Los Angeles, California 90028, 213/463-4891. Correspondence regarding advertising, reprints and subscriptions should be sent to the above address.

Publisher, Robert Black/Editor, Erwin A. Ulbrich/Editorial Coordinator, Roby Wentz/Advertising Manager, William R. Brand/Production Manager, Joyce Wallace/Circulation Manager, S. Rocklin.

SID NATIONAL OFFICERS: President, Dr. Carlo P. Crocetti/Vice President, Robert C. Klein/Secretary, Erwin A. Ulbrich/Treasurer, B. J. Lechner.

National Office Manager . . . Violet Puff

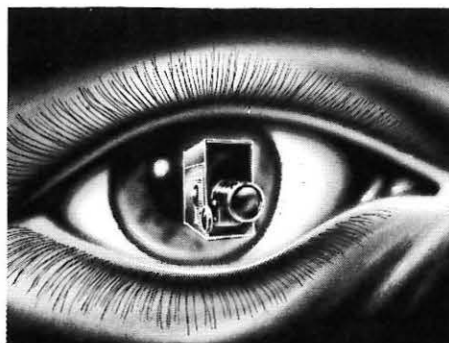

measures light as
the eye sees it!



NEW SPECTRA[®] PRITCHARD[™] PHOTOMETER

For ACCURATE LIGHT MEASUREMENTS!

- LUMINANCE
- ILLUMINANCE
- RADIANCE
- IRRADIANCE
- COLOR TEMPERATURE

For APPLIED PHOTOMETRY in...

- AERO-SPACE . . . SCIENCE
- INFORMATION DISPLAY
- MEDICINE . . . PSYCHOLOGY
- HUMAN FACTORS
- VISION RESEARCH

Write or call collect (213) 849-6017 for
data sheets, application notes or engi-
neering assistance.

PHOTO RESEARCH

A Division of KOLLMORGEN Corporation
3000 N. Hollywood Wy., Burbank, CA 91505

Circle #2 on Readers Service Card

PRESIDENT'S MESSAGE PRESIDENT'S MESSAGE

The frontiers of the technologies of our profession are exemplified by the articles appearing in our current issue. For almost twenty years, research and development in Displays has hoped to achieve the theoretical advantages of flat-panel, digitally addressed devices which can be mass-produced in competition with the ubiquitous cathode ray tube. Ever since the idea of "picture-on-the-wall TV" was first proposed, and with the rapid and economic advances of computers and their associated digital circuitry, the challenge has been a "Mount Everest" to the best display engineers and scientists of our profession. This challenge is exemplified by the time, energy and resources which have been devoted to achieving the necessary technological solutions.

That many alternative approaches to the problem have been, and are being addressed bears testimony to the difficulty of an ideal solution to the problem. From the mid-fifties, when the phenonema of electro-luminescence appeared to offer so much promise, to the present time, when light-emitting diodes, plasma displays, and liquid crystal displays are receiving so much attention, the desirability of the goal remains unchanged. It has been encouraging to note the increasing number of practical and economically viable applications of these exciting technologies in a variety of commercial applications.

While these applications are, as yet, still somewhat limited, one cannot help but feel that we are moving closer to the day when "picture-on-the-wall" television will be broadly available. And yet the technical obstacles which still remain to be overcome are quite formidable when one realizes that the competitor to these devices is the mass produced, very low cost cathode ray tube used in every TV set, with its full range of gray scale and high bandwidth and full color capability. While much still must be done, the potential in these technologies is very high.

Dr. Carlo P. Crocetti
President

EDITORIAL BOARD: Chairman, Erwin A. Ulbrich, McDonnell-Douglas Astronautics/Thomas V. Curran, Information Displays, Inc./ George Kaelin, Litton Industries, Inc./ Violet Puff, Society for Information Display/Erwin A. Ulbrich, McDonnell-Douglas/Astro/A. H. Wisdom, TRW Systems Group.
SID National Headquarters/654 N. Sepulveda/Los Angeles, Calif. 90049/Tel. 213/472-3550

SOLID STATE DISPLAYS

Some of the newer techniques of packaging displays are described; and the writer sets forth certain new packaging concepts, not yet used on production devices.

By JACK NORRIE
AMP, Inc.
Harrisburg, Pa.

■As display technology progresses, the number and type of display devices are proliferating. Because the packaging of most devices follows traditional patterns, it would appear on the surface that display packaging is not keeping pace with display technology. As evidence that packaging technology is indeed keeping pace, this article describes several of the newer packaging techniques.

The purpose is not to describe all available packaging techniques available or in use today, nor to predict the designs of the future, but rather to indicate possible trends through examples. The examples given describe some of the newer techniques and introduce, as food for thought, some totally new concepts not yet used on production devices. Although LED arrays and liquid crystal displays are used to illustrate many of the

examples, it will be obvious that other microelectronic devices can be used in a similar manner.

Variations of Traditional Approaches

The package illustrated in Figure 1 is a refinement of simple LED lead frame that makes the effective viewing angle relatively easy to control. The major improvement consists of mounting the diode inside an integral reflecting dish that has been designed to minimize light scatter and focus all available emitted light out the front of the package. The shape of this polished reflector, combined with the shape of the molded plas-

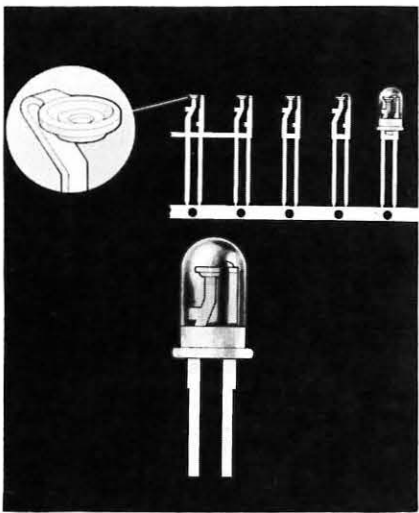

Figure 1. Coiled reflector maximizes useful light output from LED package.

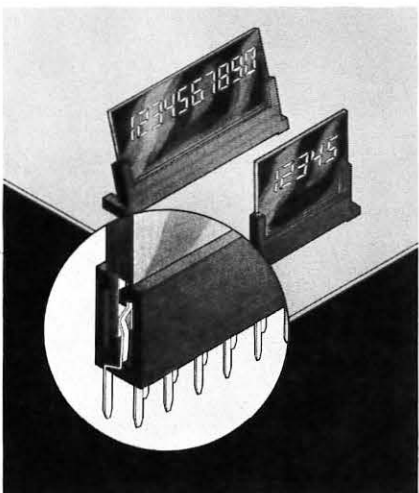

Figure 2. Receptacles for liquid crystal arrays provide viewing angles of 90°, 75° and 70° for effective viewing in either the reflective transmissive or field test.

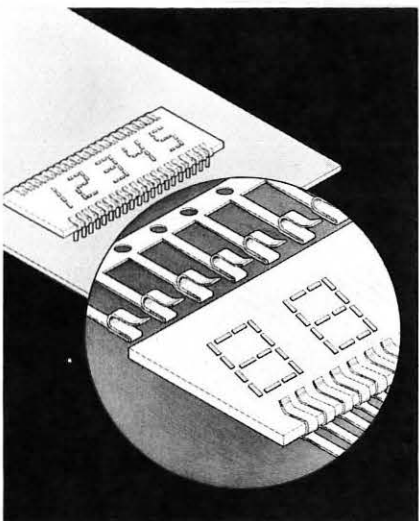

Figure 3. Automatic application machinery makes low-cost substrate clips even more desirable.

tic lens, determines the effective viewing angle.

The particular lead frame depicted here is stamped from .010" thick alloy 42, or cold rolled steel, with leads formed to accept a .025" square wire wrapping bit. Bondable gold is selectively plated onto the tip and a variety of plating options are supplied on the leads, depending on requirement of the end application.

Only minor modifications were required to convert an edgemount substrate connector into a suitable receptacle for liquid crystal displays. With a tilted base for more effective viewing angles these 40, or 80-position connectors have staggered leads to mate with .050" centerline contact pads on the display while providing more open .100" centerline spacing on the printed circuit card. See Figure 2.

This receptacle accepts a liquid crystal or substrate .062" thick at the mating edge and 2" wide (40-position) or 4" wide (80-position). Temper "C" stainless steel provides the spring qualities required to maintain a nominal contact force of 75 grams with the relatively short cantilever beams. An overall tin-lead plating protects the contact areas from corrosion and enhances solderability of the dip, or wave, solder terminations. With a maximum insertion force of 15 pounds for the 80-position version this receptacle is designed and tested for over 100 mating cycles.

Availability of Clips

Substrate clips (such as those in Figure 3) are available in a wide variety of styles and configurations and perform a function similar to that of a lead frame. Although well suited for use with hybrid circuits and LED arrays on ceramic substrates these low-cost clips cannot be used with liquid crystal displays since they rely on solder for a permanent electrical connection to the substrate metallization.

With a few modifications to the basic substrate clip, a pluggable connector can be provided. By using more contact material to achieve a generous spring, contact pressures can be increased sufficiently to obtain electrical integrity without soldering.

A simple beryllium copper or phosphor bronze contact captivated in an insulating plastic carrier strip can serve as an inexpensive plug-in receptacle for leadless substrates, leadless LED arrays, and liquid crystals. The dielectric carrier is molded to match the feed of the substrate clip. By cold forming the carrier around the stabilizing legs of the contact, the proper contact alignment is achieved. The receptacles illustrated in Figure 4 can be used for .100" or .050" centerline metallization when mounting the package perpendicular to the pc board or for .100" centerline metallization with parallel mounting.

Physical Features

Designed for 10 mating cycles the tin plated contacts exhibit less than 100-milliohm resistance under 50 millivolt open circuit test conditions. Capacitance between adjacent contacts is less than 1.0 pf at 1,000 Hz.

Physical features of these receptacles include low-profile for the parallel mounting type, and "card guides" with snap-on caps which secure the circuit into perpendicular mounted receptacles. The contacts have a split rear barrel to provide a pressure fit into plated-through holes allowing circuit testing, if necessary prior to soldering. The narrow gaps in this rear barrel also facilitate solder wicking.

A means of parallel mounting with greater mechanical security is provided the zero insertion force connector illustrated in Figure 5. Here the substrate or liquid crystal with bottom metallization drops easily between the raised bosses on the receptacle body to mate with contacts on either .050" or .075" centerlines. When the metal cap is snapped into place, each contact is deflected downward by the substrate. During this downward deflection, contact movement creates a wiping action to assure clean contact surfaces. On this and the other contacts described in this paper, generous beams provide adequate follow-up to compensate for bowed substrates. Since the cap is metal, it cannot be used (without insulation) where top metallization extends to the periphery

of the substrate.

For displays as well as logic circuits, pluggability speeds both in-house and field testing or debugging and is especially desirable when multi-digit LED arrays are packaged on the same substrate with their decoding logic. Until recently, however, pluggability implied lead-frames with their attendant reduction in yield and correspondingly higher costs.

Recent developments in leadless ceramic substrates have eliminated the lead-frames contribution to yield losses and packaging costs. Despite the absence of leads these devices are made pluggable by a new family of receptacles. For the top, or bottom, metallized ceramics, receptacles such as that shown in Figure 6 are used. The ceramic packages for which this receptacle is intended are dimensionally similar to those used for dual-in-line 40-lead packages.

In use, the ceramic package (.060" to .080" thick) is placed into the receptacle where locating bosses provide positioning guidance. The two cam-actuated retention clips are then rotated 90° to generate mating forces at each contact in the range of 125 grams. Stainless steel is used to ensure adequate spring qualities to maintain this pressure and gold plating or bright tin plating protects the contacts from corrosion. Contact resistance (for gold plated contacts) is in the 50 milliohm range when tested under 50 millivolt open-circuit conditions. Life expectancy exceeds 50 mating cycles.

Ceramic Substrates

For the newer side-metallized ceramic substrates with their large usable surface area in the same overall outside dimensions, receptacles such as that shown in Figure 7 can be used.

Accepting .080" thick ceramic packages up to 2.020" long and .578 (-.013 + .032") wide the receptacle is only slightly larger (2.115" x .830" x .240") than the ceramic package itself.

Leadless packages are plugged into the receptacle by placing the ceramic between the contact rows and pressing down until it clocks into position. With the ceramic in place, contacts are exposed for use

as test points. Although the spring contacts provide adequate retention for the package under most conditions, a plastic snap-in hold-down strap is available for applications subject to shock and vibration.

The high normal contact forces (averaging 125 grams) provided by the pre-loaded, leaf-type, stainless steel contacts is in part responsible for the low contact resistance of 20 milliohms at 50 millivolt open-circuit conditions. Contact surfaces are protected by selectively plated gold or by a tin-lead plating. Adjacent contact capacitance is in the range of .05 pf at 1,000 Hz. Contact tails are arranged in two rows of 20 on .100" spacing with .600" between rows.

Packaging With Metallized Film

A metallization process has been developed that permits depositing complex patterns of copper or nickel directly onto a variety of flexible plastic materials. The most promising commercial application of this proprietary process, which is a combination of electroless plating and electroplating, is the economical manufacture of flexible microcircuits in continuous strip form. Circuit definition is such that conductors can be easily held to .002" wide with .002" spacing between adjacent conductors. The resulting metallization exhibits extremely clean vertical sidewalls with none of the undercutting found on etched circuits as can be seen in Figure 8.

Gold dots or solder bumps can also be deposited to facilitate thermocompression bonding or reflow soldering.

Unlike similar circuits produced by an etching process, there is no adhesive between the metal circuitry and the flexible plastic backing. As a result, the only thermal limitations are those imposed by the plastic backing. Using polyimide film the circuits can withstand 400°C for 15 seconds which is more than adequate for reflow soldering or thermocompression bonding. When an active device is "flip-chip" bonded to a transparent polyimide there is the added advantage of visual inspection after bonding.

Because the metallized film can

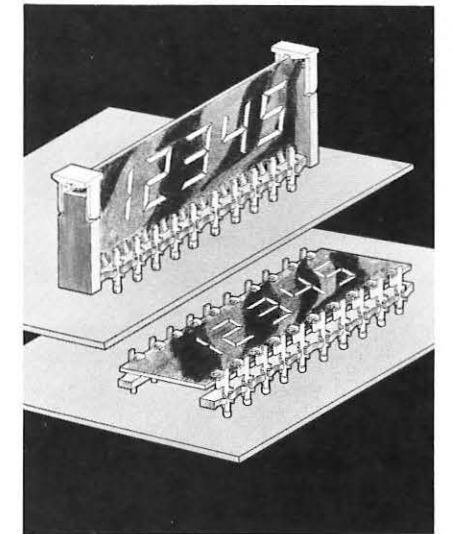

Figure 4. Since the contacts mate with both sides of the substrate, metallization can be on either, or both sides.

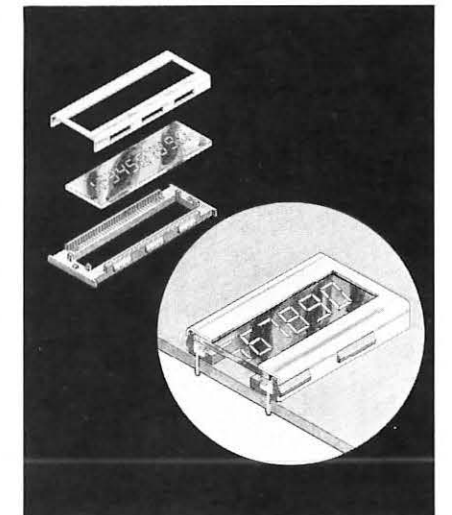

Figure 5. The cap on this zero insertion force connector locks securely into place to maintain contact pressures.

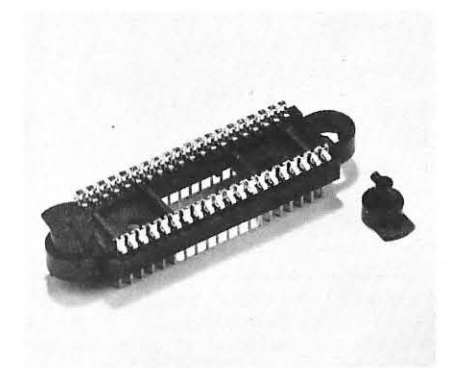

Figure 6. Mating force for this zero insertion force connector is provided by cam-actuated retention clips on each end of the housing.

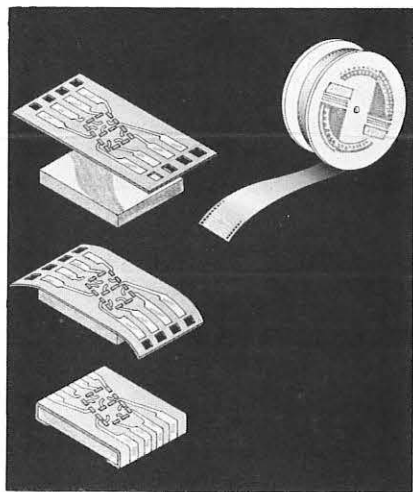
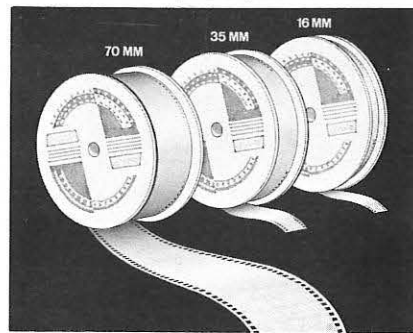
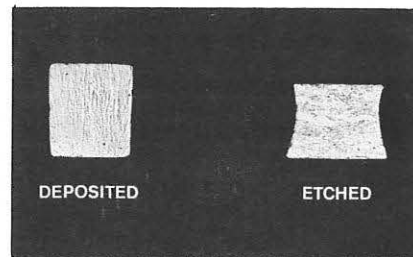
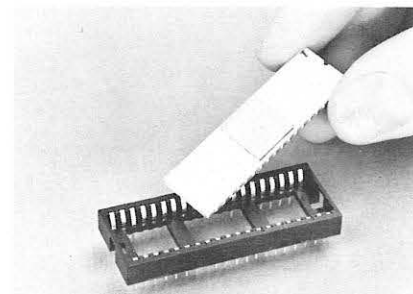

Figure 7. Extending less than .250" above the pc board, this low-profile receptacle is designed to accommodate the new side-metallized leadless ceramic packages.

Figure 8. These photomicrographs of cross-sectional conductors (approximately .002" wide) demonstrate the clean vertical sidewalls attainable with deposited circuitry.

Figure 9. Continuous reels of flexible microcircuits on sprocketed polyimide film lend themselves to automated handling. Film width is determined by circuit size and input/output requirements.

Figure 10.

be processed in continuous strips, the approach lends itself readily to automated production and testing of integrated circuitry or LED displays. For such an application the metal circuit would be deposited on sprocketed polyimide film (as shown in Figure 9).

The sprocketing provides precise indexing and transporting means. Thus, the active chips could be bonded to the film covered with a protective epoxy-like coating and the strip would index through a test station where a punch removes circuits found to be faulty without destroying mechanical integrity of the film.

Devices assembled in this manner can be packaged in a variety of ways. One of the simplest involves slicing circuits from their continuous strip and bonding them to a dielectric stiffener or aluminum heat sink. Figures 10 and 11 illustrate this method.

If the input/output contact areas are folded around the stiffener during this process, the resultant package is a pluggable device with contact areas on top, bottom and sides. Such a package is compatible with most receptacles available today for use with leadless ceramic packages as illustrated in Figures 12 and 13.

If pluggability is not required, the metallization can be reflow soldered directly onto a pc laminate. With this approach automatic or semi-automatic machines could slice the flexible circuit packages from their continuous reels and position them upside down on the pc laminate where a heated mandrel would complete the automated assembly operation.

Conclusions

The examples described in this paper clearly demonstrate that, within the confines of present technology, several new directions are open to the packaging of solid state displays. A number of variables will determine which trends of today become the standards for tomorrow. However, we at AMP are confident that leadless ceramic packages and the use of metallized film will play important roles in the future of microelectronic packaging. ■

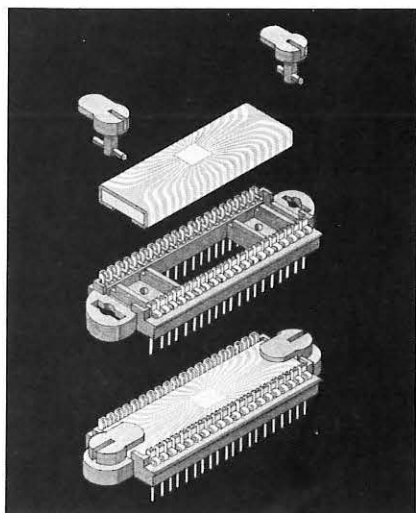
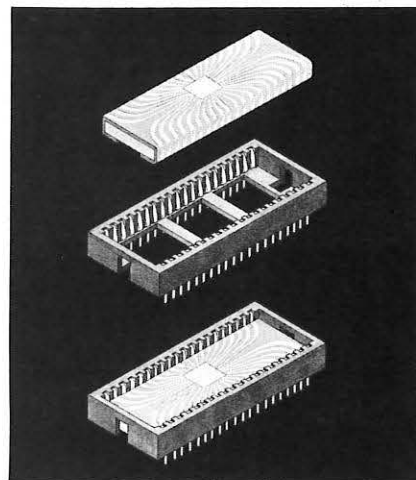
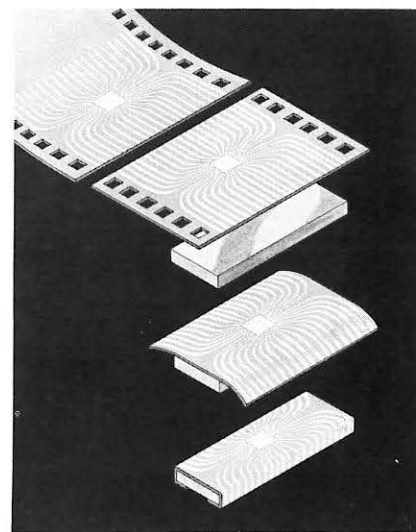

Figure 11. Circuit patterns attainable with metallized film can provide top, side or bottom contact areas.

Figure 12.

Figure 13. By maintaining overall package dimensions similar to those of dual-in-line leadless ceramics, metallization is compatible with any leadless connecting means available today.

Directory of Manufacturers of Light Emitting Diodes

Antex Industries Inc.
1059 E. Meadow Cir.
Palo Alto, Calif. 94303
415/326-2411
D. Holst

Bowmar Instr. Corp.
7329 E. Stetson
Scottsdale, Arizona
602/947-7841
James W. Clifton, Pres.

Chicago Miniature Lamp Works
4433 N. Ravenswood Ave.
Chicago, Ill. 60640
312/784-1020
R. Galarneau

Computer Diode Corp.
Pollitt Dr. S.
Fairlawn, N.J. 07410
201/797-3900
J. La Bruna

Data Display Products
8036 Westlawn Ave.
Los Angeles, Calif. 90045
213/641-1232
Q. Lodhie

Dialight Corp.
60 Stewart Ave.
Brooklyn, N.Y. 11237
212/497-7600
P. Malecka

Drake Mfg. Co.
4626 N. Olcott Ave.
Harwood Heights, Ill. 60656
312/867-7227
J. Krutek

Electro-Nuclear Lab. Inc.
115 Independence Dr.
Menlo Park, Calif. 94025
415/322-8451
J. Oliver

Fairchild Camera &
Instrument Corp.
401 Ellis St.
Mountain View, Calif. 94040
Art Heller, Adv. Dir.

Fairchild Microwave &
Optoelectronics Div.
4001 Miranda Ave.
Palo Alto, Calif. 94303
415/493-3100
R. Lanford

Fairchild Semiconductor
Components Group
464 Ellis St.

Mountain View, Calif. 94040
415/962-5011
J. Luke

Fairchild Space & Defense
Sys. Div.
Fairchild Camera Instr. Corp.
300 Robbins La.
Syosset, N.Y. 11791
516/931-4500
F. Schmidt

Ferranti Electric Inc.
E. Bathpage Rd.
Plainview, N.Y. 11803
516/293-8383
J. Brush

General Electric Co.
Miniature Lamp Prods. Dept.
Nela Park
Cleveland, Ohio 44112
216/266-2121
E. O'Hara

General Sensors Inc.
Box 231
Athens, Texas 75751
214/OR 5-5229
D. Furey

Hartman Systems Div. A-T-O Inc.
360 Wolf Hill Rd.
Huntington Station, N.Y. 11746
516/HA 7-7500
C. Poppe

HEI Inc.
Jonathan Ind. Ctr.
Chaska, Minn. 55318
612/448-3510
P. Spaulding

Hewlett-Packard
620 Page Mill Rd.
Palo Alto, Calif. 94304
Gary Spear, Adv. Mgr.
Hewlett-Packard
1501 Page Mill Rd.
Palo Alto, Calif. 94304
415/493-1501
J. Petrak

Industrial Devices Inc.
Edgewater, N.J. 07020
201/224-4700
B. Schnoll

Industrial Electronics Engineers
7720 Lemona Ave.
Van Nuys, Calif. 91405
213/787-0311
Tom O'Gorman

Instrument Displays Inc.
223 Crescent St.

Waltham, Mass. 02154
617/894-1577
T. Chadurjian

Lamps Inc.
19220 S. Normandie Ave.
Torrance, Calif. 90502
213/323-7578
J. Fenton

Leecraft Mfg. Co. Inc.
21-16 44th Rd.
Long Island City, N.Y. 11101
212/EX 2-8800
T. Marine

Litronix Inc.
19000 Homestead Rd.
Cupertino, Calif. 95014
408/257-7910
D. Fraser

Master Specialties Co.
1640 Monrovia
Costa Mesa, Calif. 92627
714/642-2427
S. Brown

Monsanto-Electronic Special
Products
10131 Bubbs Rd.
Cupertino, Calif. 95014
408/257-2140
M. Meltzer

MOS Technology Inc.
Valley Forge Corporate Center
Norristown, Pa. 19401
215/666-7950
Motorola

195 Spangler
P.O. Box 66125
O'Hare International Airport
Chicago, Illinois 60666
Peary Nelson, Marketing Director

Motorola Semiconductor
Products Inc.
Box 20912
Phoenix, Ariz. 85036
602/273-6900
R. O'Connor

National Semiconductor Corp.
2900 Semiconductor Dr.
Santa Clara, Calif. 95051
408/732-5000
F. Kuamme

Opea Inc.
330 Talmadge Rd.
Edison, N.J. 08817
201/287-0355
D. McManus

turn to next page

Optel
Box 2215
Princeton, N.J. 08540
Peter Stearns

Optical Coating Laboratories Inc.
2789 Geffen Ave.
P.O. Box 1599
Santa Rosa, Calif. 95403
Mrs. J. Frushower

Optron Inc.
1201 Tappan Circle
Carrollton, Texas 75006
Charles Bates

Optronics International Inc.
7 Stuart Rd.
Chelmsford, Mass. 01824
617/256-4511
M. Bryant

Pinlites Div. Refac.
Box 453
Caldwell, N.J. 07006
201/575-8820
M. Richards

Plessey Electronics Corp.
170 Finn Ct.
Farmingdale, N.Y. 11735
516/694-7377
B. Erde

RCA Electronic Components
415 S. Fifth St.
Harrison, N.J. 07029
201/485-3900

RCA Government &
Commercial Systems
Marne Hwy. & Borton Landing Rd.
Moorestown, N.J. 08057
609/963-8000
G. Prestwich

Readouts Inc.
Box 149
Del Mar, Calif. 92014
714/755-2641
M. McKim

Santa Barbara Research Center
75 Coromar Drive
Goleta, Calif. 93017
805/968-3511
P. Granke

Sensor Technology Inc.
21012 Lassen St.
Chatsworth, Calif. 91311
213/882-4100
I. Rubin

Skan-A-Matic Corp.
Rt. 5
West Elbridge

New York, N.Y. 13060
315/689-3986
P. Mims

Spectronics
541 Sterling Drive
Richardson, Texas 75080
214/231-5381
G. Ward Paxton

Starnetics Co.
Box 9308
North Hollywood, Calif. 91609
213/769-8437
A. Jennings

TEC Inc.
9800 N. Oracle Rd.
Tucson, Ariz. 85704
602/297-1111
B. Hamilton

Teltron Inc.
940 Willow St.
Pottstown, Pa. 19464
215/326-2127

Texas Instruments Inc.
Box 5012 MS 84
Dallas, Texas 75222
214/238-2011
Roland Kalmbach

Unique Devices Co.
Box 70
Bountiful, Utah 84010
801/295-4252

United Mineral & Chemical Corp.
129 Hudson St.
New York, N.Y. 10013
212/966-4330
H. Rosenthal

UPI Semiconductor Div.
United-Page Inc.
481 Getty Ave.
Paterson, N.J. 07503
201/279-7500

Xciton Corp.
Shaker Park
5 Hemlock St.
Latham, N.Y. 12110
Ben Howell

Viewers Awards

Electro-Optical Mechanisms, Inc. recently received two (2) DSA awards that will amount to over 3.4 million dollars for the Mini-cats viewer and viewer/printer program. According to a spokesman for the company EOM has designed a new viewer and viewer/printer, both viewer systems are of a common design to ease spare parts logistics.

Packaging of Multi-Character LED Modules With Self-Contained Driving Circuitry

By including driving circuitry in the same package with LEDs, certain advantages are realized. These include fewer external connections and reduction in the size of the module.

By H. T. GROVES
Litton Systems, Inc.
Data Systems Division
Van Nuys, California

Light emitting diodes have projected lifetimes ranging up to one million hours. Because they are solid state devices, they are potentially capable of meeting military environmental requirements of temperature, mechanical shock, vibration, and temperature cycling. They are also compatible with voltages used in computers. Because this combination of properties is ideal for computer display devices, an investigation into their use on small militarized computers was initiated. Early in the investigation it was determined that there were advantages to be realized by including the driving circuitry in the same package as the LED's.

One of the major advantages is a reduction in the number of ex-

CATHODE RAY TUBES

WE OFFER YOU TECHNICAL ABILITY FOR ANY SPECIAL CRT AND DISPLAY SYSTEM

CRT
FIBER OPTIC FACE
BACK PORTED
MONOSCOPES
HIGH RESOLUTION
CUSTOM GEOMETRIES
PHOSPHOR SCREENS
ELECTRON OPTICS.
SYSTEMS
FLYING SPOT SCANNERS,
MONITORS, FIBER OPTIC
PRINTERS, DATA TERMINALS.



DESIGN — DEVELOPMENT —
PRODUCTION — TUBES AND
SYSTEMS.

M. SADOWSKY S. CARLISLE P. KEEGAN

SPECIAL PURPOSE TECHNOLOGY CO.

16300 LINDBERGH STREET, VAN NUYS, CALIFORNIA 91406
TELEPHONE: (213) 989-4610

Circle #3 on Readers Service Card

ternal connections. See Figure 1. If we consider, as an example, a module composed of two packages, one containing eight LED characters of 35 dots, each in 5 x 7 arrays, and the other containing the driving circuitry in hybrid or LSI form, we find that the LED package requires one external pin for each of 40 columns of seven LED's, and one pin for each of seven rows of 40 LED's, or a total of 47 external pins. The driving circuitry package would require 47 matching external output pins, plus at least two data inputs, two voltages, two clock inputs, and ground. The entire module of two packages would thus require a total of 101 external pins. By combining the two into a single package the row and column connections between the two are eliminated, thus reducing the total of external connections to seven. This reduction in the number of external pins reduces the number of interconnecting solder or wire wrap joints necessary to join the parts of the module into a display, thus reducing system assembly labor and increasing reliability. If the package is made as a plug-in device, there is a saving on connector costs resulting from the reduction from 101 to 7 pins, and again, a reliability improvement.

Wire Bond Interconnections

If the driving circuitry is made in a separate package in hybrid form, there are wire bond interconnections from the components to the substrate and from the substrate to the pins. Many of these can also be eliminated by combining the LED's and the driving circuitry into a single package. The total reduction of interconnections achieved by using the single package approach offers a significant potential increase in reliability of the module.

Another advantage of the single package approach is a reduction in the size of the module. Using the same example, a hybrid package containing the driving circuitry alone would be approximately 3/4" x 1". The LED package, if it con-

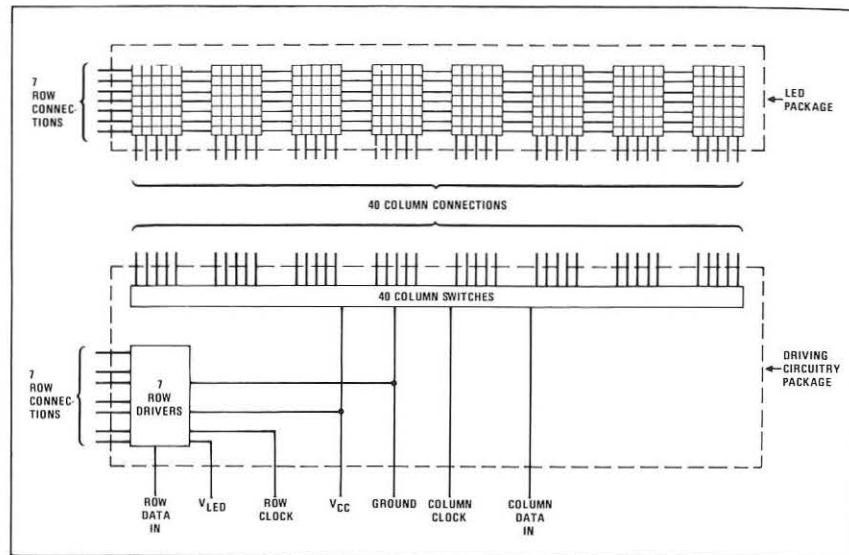

Figure 1.

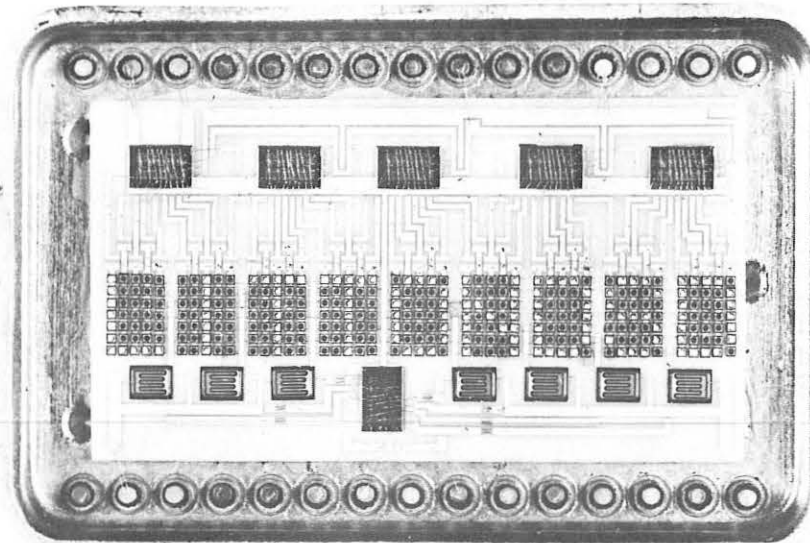

Figure 2.

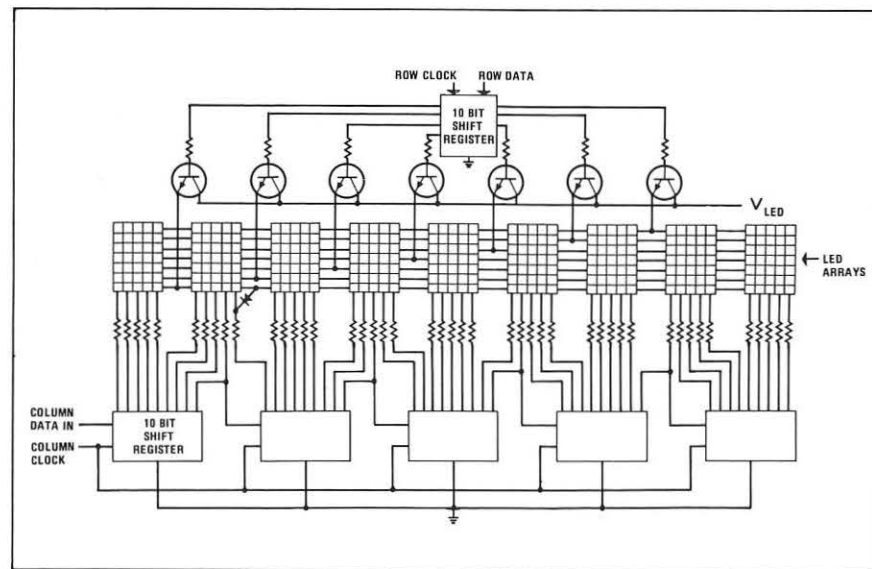

Figure 3.

tained 8 LED arrays of typewriter capital letter size would be about 1/2" x 1". By combining the two in a single package it is practical to reduce the total module size to about the same size as the driving circuitry package alone. This saving comes about by eliminating some of the package walls and the space required for the large numbers of external pins by the two package approach. The saving will be demonstrated on an actual module design in a later section of this article.

Feasibility Module

Using the single package approach, a feasibility module was designed and fabricated as a nine character plug-in device. This device is shown in Figure 2. Each LED in the arrays of 35 was individually die mounted on a thin film ceramic substrate. The LED's were 0.020 inch square with 0.005 inch space between, resulting in characters 0.175 inch high x .120 wide. TTL devices and transistors were also die mounted to the substrate to make up the driving circuitry. The substrate also contained 47 thin film resistors for current limiting. All interconnections between LED's, IC's, transistors and package were made by thermo-compression bonded gold wires. A block diagram of the circuit is shown in Figure 3. As shown on the diagram, only seven external connections were required for this module. When connected to a keyboard and an appropriate display generator, the module displayed the ASCII character set legibly in an ambient light of approximately 80 ft. candles.

Based upon the successful operation of the feasibility module, it was decided that a new module would be designed and fabricated. A prime requirement was that this module could be used in multiples in all common computer and teletype displays. The most common line lengths are 40, 64, 72, 80, 96 and 120 characters, all of which are divisible by 8. Therefore, an eight character module was tentatively selected. Further study showed that 8 LED characters per module was compatible with commercially available drive components.

NEREM 73

6. DISPLAY TECHNOLOGY SEMINAR
Wednesday and Thursday
November 7 & 8

Commonwealth Ballroom of the Sheraton-Boston Hotel
Seminar Chairman: J. E. Bryden, Raytheon Co., Sudbury, MA

9:30 a.m., Wednesday

6.1 GENERAL PURPOSE DISPLAYS

- Chairman: J. E. Bryden, Raytheon Co., Sudbury, MA
- INTRODUCTION - CHANGING CONCEPTS - J. E. Bryden, Raytheon Co., Sudbury, MA
- APPLICATIONS OF MODULAR ARCHITECTURE TO COMMAND/DECISION AND SITUATION DISPLAYS. S. B. Shuck, Raytheon Co., Sudbury, MA
- MULTI-SENSOR/MULTI-FUNCTION DISPLAYS FOR COMMAND AND CONTROL SYSTEM - D. P. Bangert, Sanders Associates, Nashua, NH
- DIGITAL TV GRAPHICS - H. C. Hendrickson, Philco-Ford, Palo Alto, CA
- INTEGRATED DISPLAYS FOR THE SPACE SHUTTLE - E. J. Reilly, North American Rockwell, Downey, CA

2:30 p.m., Wednesday

6.2 GENERAL PURPOSE DISPLAYS

- Chairman: J. E. Bryden, Raytheon Co., Sudbury, MA
- DISPLAYS IN AIR TRAFFIC CONTROL - J. G. Levinthal, Raytheon Co., Wayland, MA
- PROGRAMMING A GENERAL PURPOSE DISPLAY - J. F. Callan, Evans and Sutherland Computer Corp., Salt Lake City, UT
- REVIEW OF LARGE SCREEN DISPLAYS - W. E. Good, General Electric Co., Syracuse, NY
- INTELLIGENT SATELLITES FOR INTERACTIVE GRAPHICS - A. van Dam and G. M. Stabler, Brown Univ., Providence, RI
- MARKETS FOR GENERAL PURPOSE GRAPHICS - A. D. Hughes, Alltech Computer Systems, Pennsauken, NJ

9:30 a.m., Thursday

6.3 DATA ENTRY

- Chairman: G. C. Kinney, MITRE Corp., Bedford, MA
- FACTS AND FALLACIES ABOUT DECISION INPUT - G. C. Kinney, MITRE Corp., Bedford, MA
- LIGHT PEN TECHNIQUES - W. P. Olson, Sanders Associates, Nashua, NH
- TOUCH SENSITIVE DATA ENTRY - R. Hamaguchi, Instronics, Ogdensburg, NY
- ELECTRO-OPTIC TOUCH-ENTRY DEVICE - F. T. Buhler and B. E. Loucks, Philco-Ford, Palo Alto, CA
- THE CAMERA AS A DATA ENTRY DEVICE - V. J. Fowler, GTE Labs, Waltham, MA
- A NEW DATA TABLET USING MAGNETOSTRICTION - A. Whetstone, Scripto-Graphics, Fairfield, CT
- MANUAL DIGITAL POSITIONING IN TWO AXES: A COMPARISON OF JOYSTICK & TRACKBALL CONTROLS - M. H. Meher, Measurement Systems, Inc., Norwalk, CT
- KEYBOARDS AND THEIR APPLICATIONS - D. A. Pople, Honeywell, Freeport, IL

2:30 p.m., Thursday

6.4 FLAT PANEL DISPLAYS

- Chairman: I. Reingold, US Army Electronics Command, Ft. Monmouth, NJ
- INTRODUCTION - I. Reingold, US Army Electronics Command, Ft. Monmouth, NJ
- PLASMA PANEL AND PROCESSOR - W. A. Hamilton, Raytheon Co., Sudbury, MA and R. Abbott, Owens-Illinois
- LIGHT EMITTING DIODES IN ALPHANUMERIC DISPLAYS - W. D. Stewart, Monsanto Co., Cupertino, CA
- DIGISPLAY - A DIGITALLY ADDRESSED FLAT PANEL CRT - L. A. Jeffries and J. R. Rusk, Northrop Corp., Palos Verdes Penins, CA
- FIBER-OPTIC FLAT PANEL CRT - H. C. Hendrickson and B. C. Loucks, Philco-Ford, Palo Alto, CA
- LIQUID DISPLAYS - J. Ferguson, International Liquid Crystal Co., Cleveland, OH
- ELECTRO-OPTICAL DIPOLE FLUIDS AND THEIR APPLICATIONS TO DISPLAY - A. M. Marks, Marks Polarized, White-stone, NY

REGISTRATIONS REC'D BY OCT. 24
 IEEE Members \$55 Non-Members \$75
 REGISTRATIONS REC'D AFTER OCT. 24
 IEEE Members \$65 Non-Members \$85
 Checks payable to:
 NEREM-73
 31 Channing St.
 Newton, MA 02158
DISPLAYS

Name _____
 Address _____

Circle #4 on Readers Service Card

A human factors study of character size and spacing was conducted. Because we were primarily concerned with displays which were to be viewed by an operator seated at a console rather than displays which would be viewed from greater distances, only relatively small character sizes, less than 5/16" high, were included in the study. All character mock-ups for the study were made with clear dots on black photo film and back lighted with light of the same intensity and color as that emitted by red GaAsP LED's.

Height Advantage

The study showed that a 3/8" high character appeared visually to be approximately 3/16" high, or 150% of the actual character height. Characters of this height could be read easily at distances of 48 inches or more by persons of average eyesight. This small character was also found more legible at close viewing distances because it gave the appearance of an almost continuous line, where larger characters, particularly over 1/4 inch high, appeared as a series of separated dots at close viewing distances and were, therefore, somewhat less legible. It was also found that legibility was not degraded until the space between the characters became greater than 1/4 the character width. Investigation with LED manufacturers revealed that a 0.125 high x 0.090 wide character size was compatible with existing LED diffusion and metallization mask sizes, so this size was selected for the new module.

A character to character spacing of 0.060 inch, or 2/3 the character width was selected as a compromise between legibility and overall length of the module. This spacing also met the packaging limitation inherent in maintaining the same spacing between the last character of one module and the first character of the next module when several are placed end to end for long lines of characters. If the characters are too closely spaced, the thickness of the package ends is too great to maintain the charac-

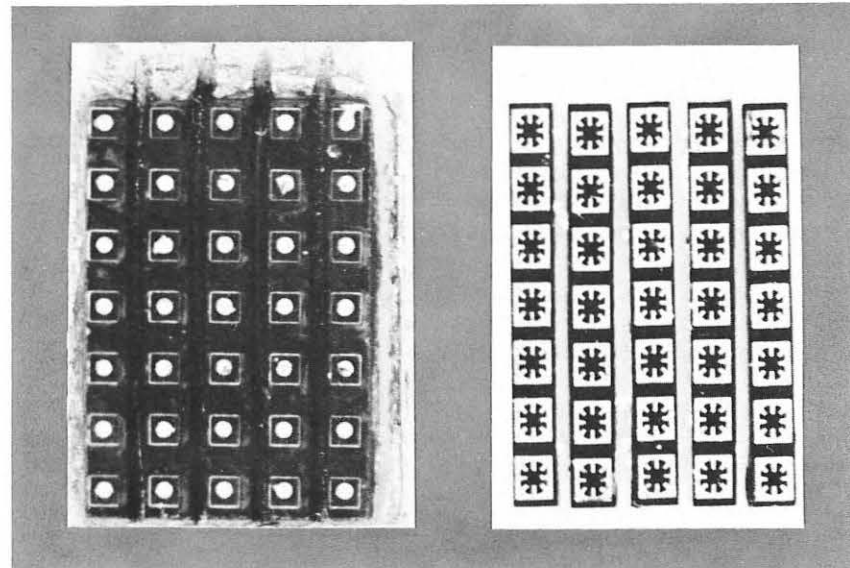

Figure 4.

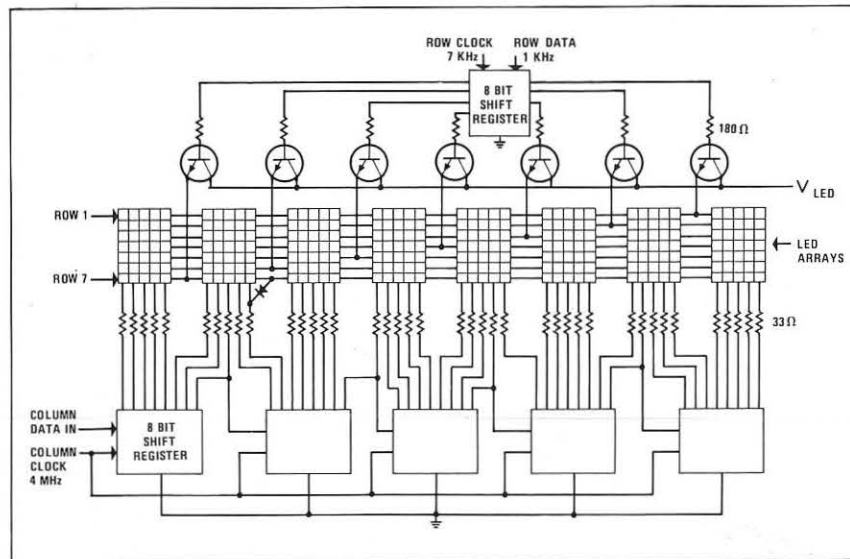

Figure 5.

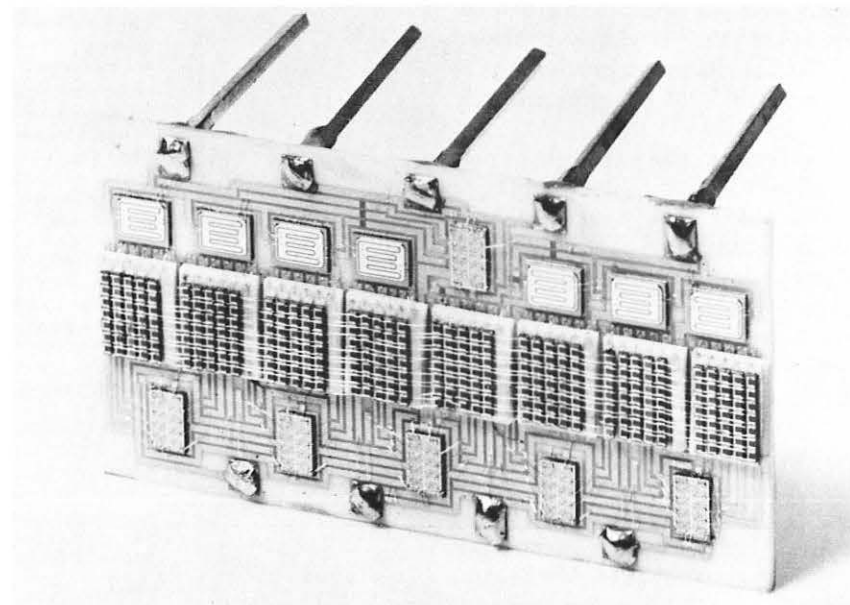

Figure 6.

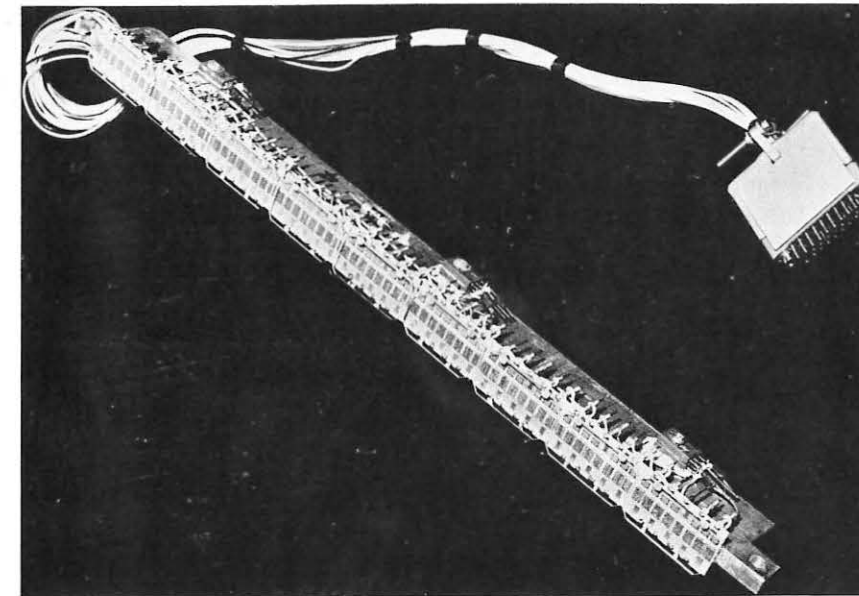

Figure 7.



Figure 8.

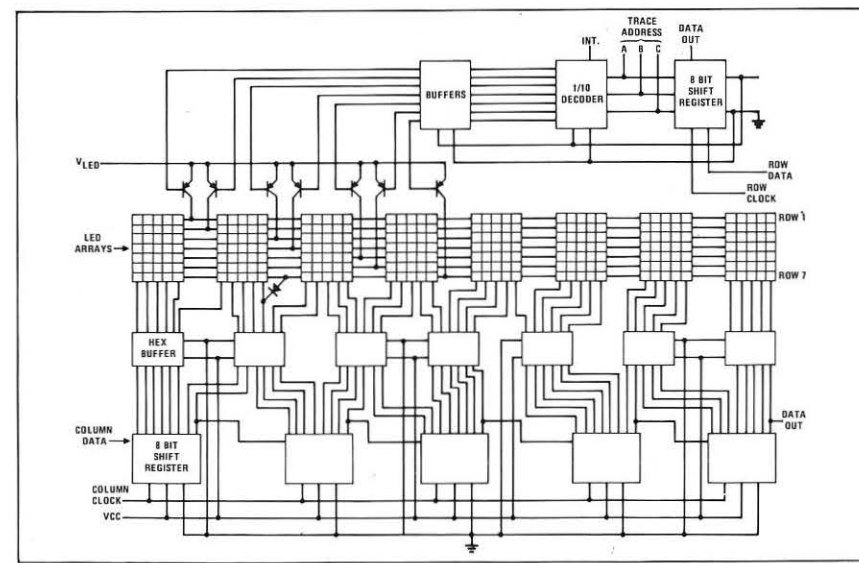

Figure 9.

ter spacing from one module to the next. For example, if we assume a minimum end wall thickness of 0.020 and a space of 0.010 between modules, the character spacing must be 0.020 x 2 plus 0.010 or 0.050 inch to maintain spacing continuity from module to module. If the spacing is not maintained, it gives the appearance of missing characters, or the breaking up of a word occupying parts of two adjacent modules, thereby affecting the legibility of the display.

In cooperation with LED vendors, a 35 dot semi-monolithic LED array was developed. Two vendors' versions of this array are shown in Figure 4. Each array shown on the slide has five monolithic strips of 7 LED's each die attached to five metallized stripes on a ceramic substrate. The metallized stripes extend past the end of the LED strips so that column wire bond connections can be made.

8-Character Module

An eight character module with self-contained driving circuitry was designed and nine pieces fabricated. A block diagram of the circuit is shown in Figure 5. Figure 6 shows the module with the cover left off so that details can be seen. This module was 1.070 inch long by 0.575 inch wide. The wire wrap pins projecting toward the rear were inserted through holes in the ceramic substrate and brazed to metallized pads on the front. This film resistors and conductors were etched on the substrate. The TTL shift registers and transistors were die bonded to the substrate and electrical connections were made by thermocompression bonded gold wires. The LED arrays were fastened to the substrate with a thermally conductive, electrically insulating epoxy adhesive. The LED anodes were connected in 7 rows of 40 LED's each by ultrasonically stitch bonded aluminum wires. This module had nine external pins, the two extra pins being duplicate V_{cc} and ground connections

turn to page 18

SID

PROCEEDINGS

The SID Proceedings are the major contribution to the literature in the field of information display. Carefully prepared formal papers, many presented at SID conferences and symposia, not only contribute to the state-of-the-art, but also supply historical data and survey articles concerning the field.

From 1963-1968, SID proceedings were published annually or semi-annually.

MICROFICHE Plans are under way to make available microfiche versions of all proceedings. As printed volumes go out-of-print they will be replaced with microfiche.

Contact SID for price and availability.

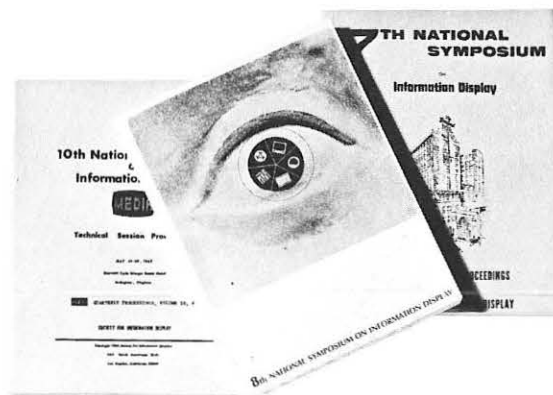

VOLUME 1, March 1963, Santa Monica, Calif. Proceedings of SID's First Conference emphasizes scan conversion and bright display, multicolor projection system, color data, a photographic large screen display system, high ambient light displays systems, and human performance engineering.

159 pages, 93 illustrations . . . \$20.00.

VOLUME 2, October 1963, New York, N.Y. Papers for the Second Proceedings were selected on the basis of their relevance to problems of current and future interest. Partial contents include information systems, information systems, information science and responsibility, laser display techniques, and multicolor console processor projector.

283 pages, 145 illustrations . . . \$20.00.

VOLUME 3, February 1964, San Diego, Calif. This symposium concentrated on new techniques and devices as well as system design and human factors. The proceedings includes specification and test of display equipment, high ambient light display system and alpha-numeric CRT.

299 pages, 120 illustrations . . . \$20.00.

VOLUME 4, October 1964, Washington, D. C. The Fourth National Symposium explored the information display on land and in the air. Proceedings detail air traffic control, a matrix controlled generator, signal distribution for a large scale display, display requirements of the integrated management information systems, and a method for generating television mosaic displays.

383 pages, 179 illustrations . . . \$20.00.

VOLUME 5, February 1965, Santa Monica, Calif. This proceedings records the interplay between designers and users of display equipment and devices. Partial contents: Information systems for business and industry, developments in group displays, displays in simulation, developments in components and systems, vehicular traffic, and post 1970 displays.

332 pages, 148 illustrations . . . \$20.00.

VOLUME 6, September 1965, New York, N. Y. Proceedings of this two-day symposium include papers on dichroic filters and additive color displays, real time CRT-photochromic projection display, visual write-erase-nonstore and electrical readout, batch-fabricated computers, and challenges to the display field.

185 pages, 134 illustrations . . . \$20.00.

VOLUME 7, October 1966, Boston, Mass. This proceedings presents advances in both the theory and the application of information display. Contents (partial): Display devices and techniques, information processing as a function of display format, the observer-human factors and performance, display systems, and display standards.

287 pages, 184 illustrations . . . \$20.00.

VOLUME 8, May 1967, San Francisco, Calif. Papers in this Proceedings provide a graphic portrayal of the state-of-the-art and future insights. Contents include: Dry silver recording materials, the application of photochromics to color display, the plasma display panel, anaglyph stereoscopic CRT display system.

290 pages, 251 illustrations . . . \$20.00.

VOLUME 9, May 1968, Los Angeles, Calif. This proceedings records the ever expanding science of data transfer between men and machines. Contents (partial): Driver performance using an experimental route guidance system, computerized fingerprint classification, a high resolution closed circuit remote viewing system, and Holographic Real-Time display.

207 pages, 172 illustrations . . . \$20.00.

QUARTERLY ISSUES

Since 1969, SID Proceedings have been published in typeset quarterly issues. This procedure allows the most current information to be rapidly presented.

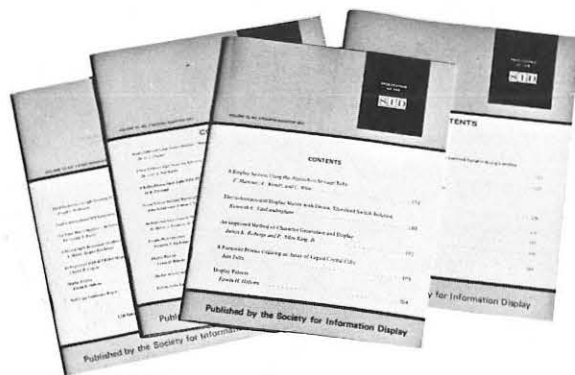

VOLUME 10, 1969

No. 1. Issue includes display technology, display programming and characteristics of automated display consoles. 65 pages, 45 illustrations . . . \$12.00

No. 2. Partial contents feature computer graphics terminal, ATC display and measurement of a CRT spot. 222 pages, 100 illustrations . . . \$20.00.

No. 3. Contents of this publication include performance of CRT tubes and dot matrix displays, multisensor processing, or dynamics electrographics. 36 pages, 25 illustrations . . . \$9.00.

No. 4. Partial contents: Plasma-fluidic hybrid display, fully shaded digital video and dynamic information storage. 78 pages, 75 illustrations . . . \$12.00.

VOLUME 11, 1970

No. 1. Contents include: Character generation by MOS ROM. Survey of digital plotters and interactive graphics. 48 pages, 58 illustrations . . . \$9.00.

No. 2. Trends in computer aided design requirements of holographic displays and digital TV displays are discussed in this issue. 48 pages, 56 illustrations . . . \$9.00.

No. 3. Inexpensive electronic memories, night vision displays, ID110m and GRAIL are described. 48 pages, 58 illustrations . . . \$9.00.

No. 4. Partial contents: Data compression laser photochromic display, filter effects and deflection amplifier compensation. 48 pages, 52 illustrations . . . \$9.00.

VOLUME 12, 1971

No. 1. Contents include light emitting diodes, matrix displays and display patents. 48 pages, 45 illustrations . . . \$9.00.

No. 2. Schlieren light valve, reflex electro-optic light valve and improved laser color system are included. 48 pages, 66 illustrations . . . \$9.00.

No. 3. Papers include CRT deflection system, microfilm printer for Chinese characters and index of display articles in current periodicals. 48 pages, 60 illustrations . . . \$9.00.

No. 4. Partial contents: Alphecon storage tube, ovonic threshold switch isolation and liquid crystal cells. 35 pages, 45 illustrations . . . \$9.00.

VOLUME 13, 1972

No. 1 Devoted to plasma displays, this issue contains ten comprehensive papers, on various display techniques, including low cost drivers, phosphor color, multicolor gas-discharge display and a quarter-million element display with memory. Also included is an index of display articles from current publications and abstracts of display patents. Editor: H. Gene Slottow

92 pages, 118 illustrations...\$9.00.

No. 2 This issue emphasizes important new aspects of liquid crystal technology with five full-length articles. Contents include liquid crystal display phenomena, cholesteric texture change, cholesteric-nematic phase transition and light scattering considerations. Editor: George E. Holz

32 pages, 42 illustrations...\$9.00.

No. 3 Volume includes discussion at the two-day Workshop of Display Terminals and Wired Cities held at the National Bureau of Standards in Gaithersburg during December, 1971. Contents cover applications, display terminal status, cable capabilities, summary charts of hardware and software, and a history of ASCII codes. Editor: E. A. Ulbrich

24 pages, 35 illustrations...\$9.00.

No. 4 Five papers describe new display techniques, including scanned LEDs, an 11-switch decoder, amorphous semiconductors and modular transfer function of CRTs. Editor: R. A. Ruehrwein

24 pages, 28 illustrations...\$9.00.

FUTURE ISSUES

VOLUME 14, 1973

No. 1 Volume includes selected display papers from the first USA-Japan Computer Conference. Editor: Dr. J. J. Brandinger

No. 2 A special issue dealing with display hardware/software comparisons compiled at RADCO, Rome, N. Y.

No. 3 and No. 4 Papers from the SID Symposium and Exhibit held in New York during May, 1973. Included are papers from sessions on I/O techniques, solid state displays, liquid crystals, plasma displays, perception, LED's, CRT's, and applications. Individual quarterly issues are \$9.00.

SID SPECIAL PUBLICATIONS

SYMPOSIUM DIGEST

An important facet of the SID publications are the Digest of Technical Papers prepared in conjunction with the SID international symposia. Condensation of prepared papers and summarized views of panel discussions have been prepared. These digests serve as a detailed index to the full-length papers published in the quarterly proceedings.

1970 International Symposium Digest, May 1970

New York. Contents include: Matrix displays, plasma displays, projection displays, cathode ray devices, digital image processing, human factors, character generation and display system.

128 pages, 160 illustrations . . \$15.00; Members...\$10.00.

1971 International Symposium Digest, May 1971, Philadelphia.

This issue covers presentation dealing with CRT technology, large screen projectors, color image reception, new display techniques, plasma displays, display applications, and liquid crystal displays.

144 pages, 151 illustrations . . \$15.00. Members...\$10.00.

1972 International Symposium Digest, June 1972, San Francisco.

Topics include: Solid-state display technology, consoles, plasma displays, software, liquid crystal displays, CRT's, visual phenomena and peripheral equipment.

160 pages...\$15.00; Members...\$10.00.

1973 International Symposium Digest, May, 1973, New York.

This issue will include topics on display I/O techniques, solid-state display technology, plasma displays, liquid crystal displays, raster/vector graphic display systems, applications, aerospace displays, computer graphics and human factors.

Approx. 160 pages...\$20.00; Members \$15.00

HOW TO ORDER

Single issues, complete sets and subscriptions may be obtained from the Society for Information Display's Publication Department.

Address mail to: SID Publications, 654 North Sepulveda, Los Angeles, Calif. 90049. phone: (213)472-3550.

SUBSCRIPTION SERVICE

Subscriptions to SID publications give you prompt, uninterrupted service on future publications. In addition to reduced costs, subscription service saves you time and clerical effort. It also protects against increased prices during the subscription period.

Subscription to Proceedings.

Subscribers receive the four quarterly issues of the SID proceedings.

Subscription price...\$30.00 annually.

Publications Subscriptions.

Subscriptions to SID publications give you complete sets of the annual periodicals published by SID.

An annual subscription includes:

- One set of the quarterly SID proceedings.
- A subscription to the bi-monthly SID Journal.
- A copy of the annual SID Symposium Digest.

DISPLAY BOOKS

Recent Advancement in Display Media

Vol. I Out-of-print.

Vol. II This volume does much to provide the overview necessary to gain perspective on how the various display specialties juxtapose and enrich each other. Chapters describe plasma display terminals, VTOL IFR technology, fallout display systems, R&D in computer and information sciences, and computer processing for three-dimensional displays. Hard cover.

260 pages, 100 illus...\$10.00; Members...\$7.50.

Vol. III This compilation brings together extensive reviews of the literature in the field of information display. Included are electronic displays on aircraft control, digital printer/plotter graphics terminals, and experimental display processor for the DX-1, information acquisitions, and R&D in the computer and information sciences. Hard cover.

231 pages, 20 illus...\$15.00; Members...\$10.00.

Vol. II and Vol. III purchased together

price...\$15.00; Members...\$10.00.

DISPLAYS CONFERENCE PROCEEDINGS

Conference on Displays, September 1971, Loughborough, England. Organized by the Institution of Electrical Engineers in association with the Society for Information Display (British Chapter), this conference spotlighted display techniques throughout the world. Evaluation of visual displays, man as an information receiver, information retrieval systems, bi-color display tubes, heads-up displays, air traffic displays, three dimensional CRT displays.

374 pages, 215 illus...\$30.00; Members...\$20.00.

ANNUAL SUBSCRIPTION

Annual subscriptions for future issues of the SID proceedings are available. Price \$30.00. Order yours today.

From 1963-1968, SID proceedings were published annually or semi-annually.

Libraries and other organizations requiring multiple copies at the same address receive substantial price reductions when using the SID subscription service. If more than three subscriptions are required, libraries may find it advantageous to become sustaining members.

Subscription Period	One Subscription	Two Subscriptions	Three Subscriptions
One Year	\$50	\$80	\$110

Three Years \$130 \$220 \$310

Subscribers outside the United States may speed delivery by adding an airmail option of \$10.00 in the Western Hemisphere; \$15.00 in Europe; and \$20.00 in the rest of the world.

SID Journal Subscriptions.

For information concerning subscriptions to the SID Journal, please contact Blackwett Publishing Co. directly, 1605 Cahuenga Blvd., Los Angeles, Calif. 90028

SOCIETY FOR INFORMATION DISPLAY
645 North Sepulveda
Los Angeles, California 90049

which were added to avoid running these lines across the substrate. This allowed the module to be made somewhat smaller than was otherwise possible. This module was also laid out in a two package version to determine the actual space saved by the single package approach. The layout showed that the drive circuitry package would be $\frac{3}{4}$ " x 1" using standard hybrid layout rules, and the LED package would be 0.5 x 1.07 inch. The single package is thus only slightly larger than the LED package alone.

Problem Solved

The nine modules were mounted in a temporary carrier and connected to a keyboard and display generator to form a line of 72 characters. The modules performed as planned except for a problem of uneven brightness caused by voltage drop along the aluminum wires from the points of attachment to the row drivers. The problem was solved on this design by adding a second stitch bonded wire parallel to the first one.

An additional 54 modules, for a total of 63, were fabricated and used to build a 504 character computer display that could be operated in the field in a jeep mounted console. The modules were organized in seven lines of nine modules, or 72 characters per line. The nine modules in each line were mounted on an aluminum heat sink bar with the module pins connected by wire wrap to a connector on the end of the heat sink bar as shown in Figure 7. The entire bar with its attached modules could thus be easily removed from the display console and replaced for field maintenance of the display. Also, each module could be removed from the bar for factory depot replacement. The display and a portion of its keyboard is shown in Figure 8 with 251 of the possible 504 characters lighted. The display operated as planned, and has been in operation for over 18 months with no failures of modules or LED's.

After this display was completed, another 8 character module was

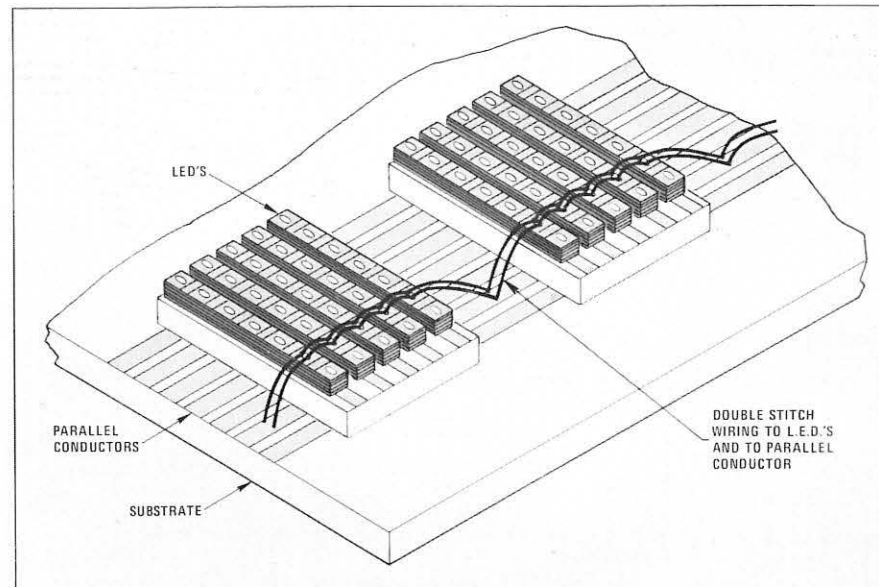

Figure 10.

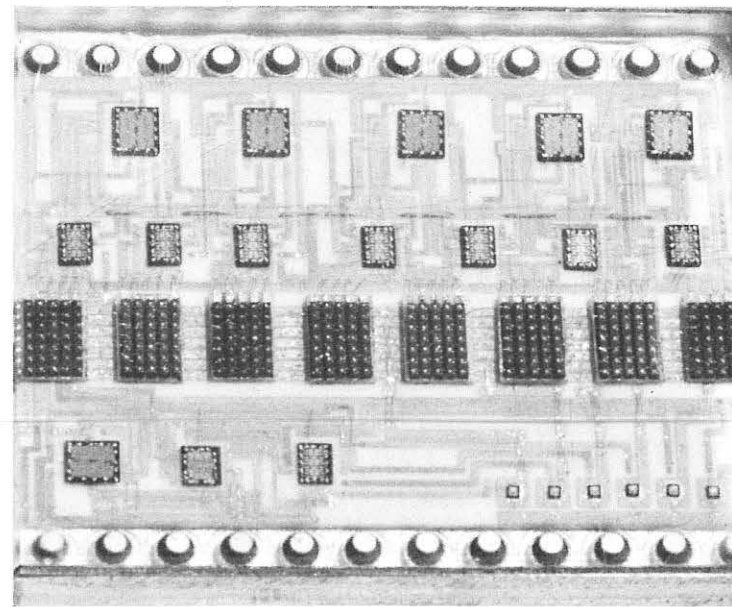

Figure 11.

designed. This module also used the semi-monolithic 35 dot LED arrays. This module was designed as a feasibility model, this time to test the use of C-MOS driving circuitry instead of the TTL used on previous modules. A block diagram of this module is shown in Figure 9. Calculations, which were later confirmed by measurements on the modules, showed that the use of C-MOS circuitry instead of TTL reduced the power by a factor of 10 in the standby mode and by a factor of 4 in the operating mode with 8 characters displayed.

In order to eliminate the uneven brightness caused by voltage drop on the row wiring, a new technique was developed. This is illustrated in Figure 10. Two stitch

bonded aluminum wires were attached to each LED, with the wires connected between each array to conductive traces which ran under the arrays and parallel to the row wires. Each LED was thus connected to the row driving circuitry at four points. Using this technique, a calculation based upon known failures rates of ultrasonically bonded aluminum wires gives a projected failure rate of 0.0014 per million module hours, assuming that more than two LED failures per character will render the character illegible. The character set displayed by the modules was designed so that any two LED's in a character could become inoperative and still allow any character to be legible and dis-

tinguishable from any other character. A photo of the module is shown in Figure 11. The module was designed for encapsulation in a clear epoxy material which has been extensively tested for physical degradation and circuit failures by exposure to thermal shock, high temperature storage and humidity. Ten of these modules were fabricated and built into a prototype hand held message input device as a two line, 40 character per line display.

In summary, the development program has demonstrated the following:

1. For close viewing distances, such as an operator seated at a console, a $\frac{1}{8}$ inch character height with character spacing less than $\frac{1}{4}$ the character width has been shown to be satisfactory. This size is also compatible with LED manufacturing processes.
2. Brightness of red GaAsP LED's when driven with commercially available components is adequate for bright ambient light viewing.
3. The concept of including driving circuitry in the same package as the LED's reduces external connections and results in a small volume, low cost, high reliability modular LED display.
4. Either TTL or C-MOS components can be used successfully in multicharacter LED packages with self-contained driving circuitry.
5. An eight character module is compatible with commercially available drive components, and with line lengths most commonly used in computer displays. ■

Correct Address Please

The National Office has an incorrect mailing address for the following members. If you are a friend or business associate of one of them, please pass the word to him to advise National Office (address above) of his new mailing address: Robert C. Carter, Jr.; Kenneth E. Groves; Robert F. Hill; J. A. Munro; Edward R. Stephan; John E. Tahl; Robert R. Weekley.

Zworykin Award

Professor Donald L. Bitzer of the University of Illinois at Urbana-Champaign has received the 1973 Vladimir K. Zworykin Award of the National Academy of Engineering for his development and application of the PLATO computer-based education system.

The award is for "outstanding achievement in the field of electronics applied in the service of mankind" and is designed to provide "timely recognition of outstanding achievement by an individual in the early stages of his career."

Ecology Meeting September 10-12

Lewis Winner of SID is consultant to a 3-day forum on earth environment and resource crises to be held September 10-12, Marriott Motor Hotel, Philadelphia. Speakers will include geo-physicists, meteorologists, environmentalists and electrical and electronic engineers, who will assess projects which can contribute to the advancement of physical, life and social sciences, and engineering. For information, contact Lewis Winner, 152 W. 42nd St., New York, N.Y. 10036.

Contributions Invited To The **SID** Journal

Information display professionals are invited to submit papers for consideration by the Editors and Editorial Board of the **SID JOURNAL**, the new official publication of the Society for Information Display. In submitting papers, authors should keep in mind the following:

Subject matter may include man-machine interfaces, information theory, operations research analysis, display system design, the physics of display devices and components, display optics, display electro-optics, display storage media, display circuit design, display software; and information processing.

Two copies of the manuscript should be submitted, including: (1) title, (2) author's name, (3) author's home and business address and telephone numbers, (4) abstract, (5) body of the paper including an introduction and conclusion, (6) list of footnotes and references, (7) list of figure captions, (8) figures on individual sheets, (9) tables on individual sheets, (10) author's photograph and biography.

Details of the above are as follows: The abstract should be limited to 150 words and should concisely express the major ideas of the paper. All written material should be typewritten in black, double-spaced on bond paper of letter size. All photographs should be black and white (color should be used only when absolutely necessary), glossy, and at least 4 x 5 inches with lettering that is at least $\frac{1}{8}$ -inch high (typewritten, Leroy-lettered or equivalent; no handwritten lettering should be used). Clean and clear photographic copies or originals of figures are requested; office copying machine reproductions are not considered adequate. Tables and figures should be adequately explained and understandable without reference to the text. The author's photograph should be black and white glossy. The author's biography should be limited to 150 words and include his education, present position, honors, professional societies, and S.I.D. activities.

Papers may be submitted to: Publications Chairman of S.I.D., 654 N. Sepulveda Blvd., Los Angeles, California 90049.

1973 SID Cost Centers—Result of a Study

The Society is now almost ten years old, and as it has grown, the continuously changing volunteer management has never really had a financial plan for the Society. Although the Society has been under good fiscal control from year to year and with an approved budget, etc., there has never been a cohesive total look at the finances of SID with respect to the members and the future. The Board commissioned me in June 1972 to provide such a total picture working closely with the Treasurer, R. C. Knepper. Figure 1 illustrates the results of our study for our probable situation at the end of 1973.

Three Cost Centers

The three funnels represent the three Cost Centers of the Society: The National Office, the International Symposium, and the Fall Technical Meeting. Each Cost

Center is run on a balanced basis so that income and expenses balance and no surplus or deficit exists. Provision is made to transfer funds back and forth between Cost Centers to aid in times of need but in the long run, they are to break even. This method of management sort of grew up with the Society and its volunteers and its non-profit incorporation. It provides the managers with a significant problem and that is that there is no room for error or bad estimates. It seems also to be an unwritten law that expenses occur on schedule but income does not always materialize, and thus deficits are more probable.

It should be noted that an individual member appears to be getting \$25.93 worth of services for his \$15.00 in dues. In some technical Societies, this would be an excuse for a dues increase, but this is not really necessary. In our vol-

unteer Society, what is really happening is that the advertisers, sustainers, and libraries are subsidizing the regular members. It should also be noted that our National Office operation is using \$11.15 of the \$25.93 for the coordination, integration, etc., which is relatively intangible compared to publications, exhibits, and presentations.

Money Flow

The International Symposium attendee is in a similar situation receiving \$48.33 worth of services for \$35.00 registration fee. As is shown, this is small punkins compared to the \$300. expenses and salary thought to be average for each attendee. Fortunately or unfortunately, this \$300. flows right out of the funnel without being tapped by the Society. The Fall Technical Meeting is a smaller version of the same thing.

Down at the bottom of the funnels are the valves which the elected non-salaried management are turning to effect control of the Society to bring about the desired balance. The following actions are currently being considered to assist:

1. Set up a slight surplus as the goal of combined Cost Center operations for 1974, and establish a ten-year plan for the future.
2. Consider a small increase in dues to offset inflationary pressures since 1963 (Perhaps \$3. or \$5.).
3. Consider a fees increase at the Symposiums, and how to convince exhibitors that they are effectively reaching their customers.
4. Emphasize the role of publications sales especially to libraries in the near term.
5. Eliminate inactive Chapters.
6. Assist the Journal Publisher in increasing advertising sales.

We would like your opinions on any of these ideas, and hope that this brief presentation has allowed you to spend the time to become involved. — E. A. Ulbrich,

Secretary - SID

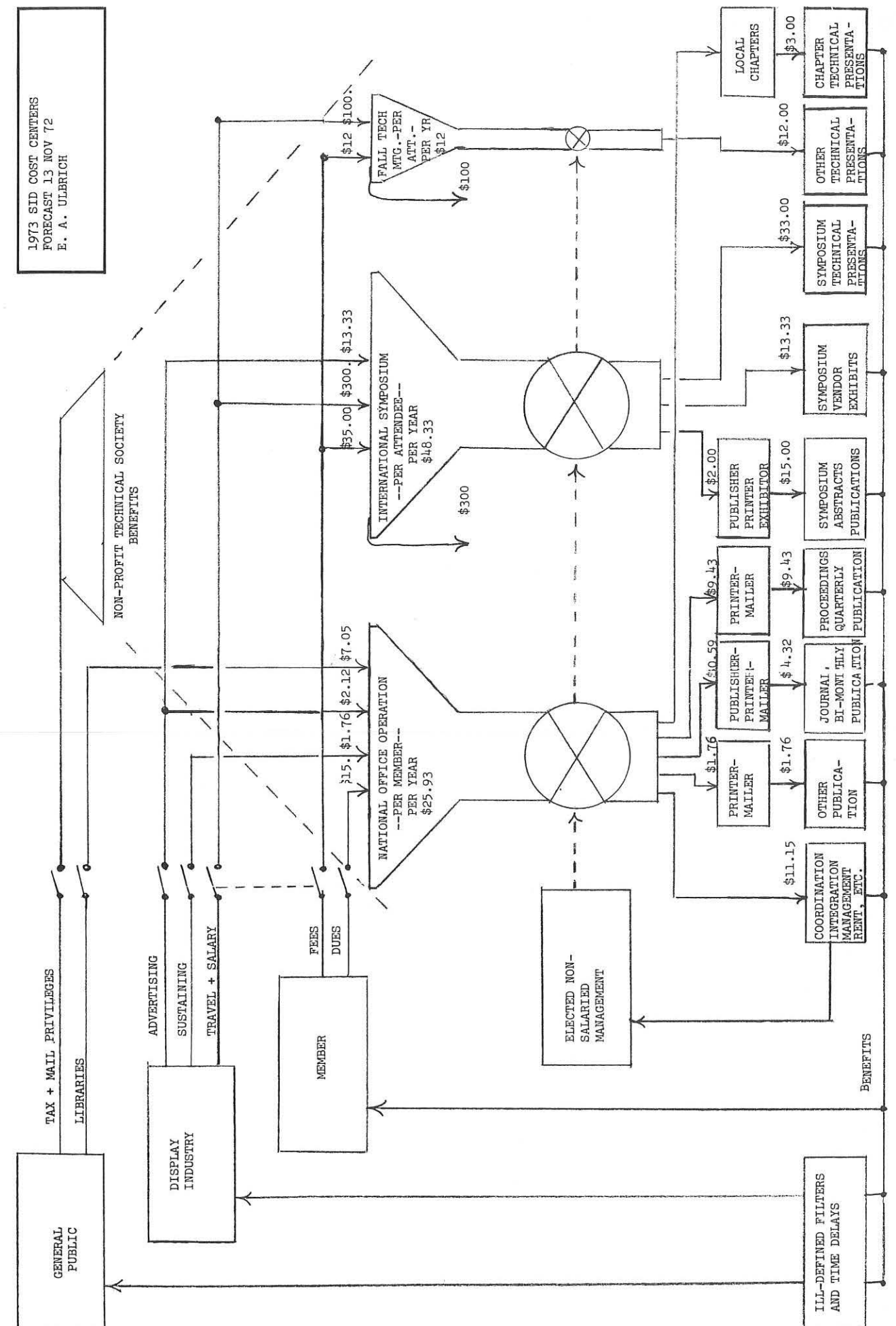

1973 SID Cost Centers

Applied in your REAR PROJECTION system

LUMISCOPE

- Permits high gain with an even field (NO "hot spots")
- Allows the use of low-powered projection apparatus
- Gives freedom from ambient lighting conditions

LUMISCOPE precision fresnel lens systems are available, machined in acrylic, up to 3 meters in diameter. Precision lenses, hot-pressed in acrylic, can be supplied up to 480 mm. in diameter. For further information contact:

RDS LUMISCOPE

P.O. Box 4143, Valley Village Station
North Hollywood, California 91607, USA
Telephone: 213/981-2116
Cable: GLICONEN-Sherman Oaks

Circle #5 on Readers Service Card

Copyright Analysis Published by ASIS

An "Analysis of Copyright Issues and Legislation" has been published by the American Society for Information Science (ASIS). This is described as "an objective study of copyright issues and pending legislation."

The report is the result of a study commissioned by the Copyright Study Group, a group of 15 professional associations, including ASIS (*see below), that requested an impartial, expert analysis of the impact on communications of copyright-revision legislation. Because of this "hands-off" policy, no one of the organizations supporting the study in any way endorses the result. The study was prepared by the Cambridge Research Institute of Cambridge, Mass., under the direction of Eugene M. Zuckert and management of Michael G. Kushnick.

Analysis of Issues

From the millions of words that have been published on the subject of copyright—such as court decisions, congressional testimony, U.S. Copyright Office studies, law review articles, and trade publications—the Institute digested and summarized the pertinent facts. The sole guideline followed by the preparers of the report was that there should be "an analysis of issues involved in present law and its operation as a result of judicial and administrative action, the pertinent issues involved in amending the law, and the probable implications of the amendments proposed."

Arthur B. Hanson, Esq., states in the Foreword to the report that "this work will stand on its own and serve as a useful guide for future studies in many fields of law. Its approach is one that can serve as a model for other legislative studies. Its impact will be felt in the fields of teaching, science, commerce, and international relations for years to come."

Price of the report to ASIS members is \$38.40; to others, \$48.00. Publications Division, ASIS, 1140 Connecticut Ave., Washington D.C. 20036.

Honor Award Texts for Two Members of SID

Following are the texts of honor awards presented at Annual Meeting, New York, May, of the Society for Information Display; and not available as the last issue of SID JOURNAL went to press.

To Mr. Irving Reingold, U.S. Army Electronics Command, Ft. Monmouth, N.J.

Citation to accompany the award of Fellow.

"Mr. Irving Reingold has demonstrated high professional performance in his own contributions and in proving high quality technical leadership in the electron beam, plasma and general display areas. His efforts have resulted in significant pioneering advances in the development of flat-panel display components and devices encompassing a number of diverse technologies. These include gas plasma excitation, solid-state light emitting diodes, electroluminescent films, flat cathode-ray tubes, and liquid crystals. His early recognition of the drive address memory and control problem associated with matrix-type flat-panel displays, and his insistence that the critical interface between the necessary circuit techniques and display viewing structure be treated in an integral fashion, have been instrumental in affecting the thinking and subsequent actions of workers in the field."

To Dr. H. Gene Slottow, Owens-Illinois, Inc., Perrysburg, Ohio:

Citation to accompany the presentation of the Frances Rice Darne Memorial Award.

"Dr. H. Gene Slottow directed an ambitious and effective research and development program at the University of Illinois. This program brought the Plasma Display concept from the invention stage to a demonstration of operating prototype displays. The results of this work along with Dr. Slottow's close involvement with other related industrial and governmental research operations were invaluable in providing motivation for industry to bring a promising new display technology from the invention and laboratory stage to the marketplace. Dr. Slottow has con-

Ulbrich Succeeds Bjelland as Editor

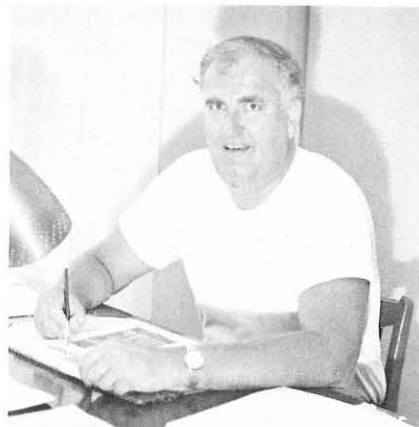

Erwin A. Ulbrich with this issue succeeds Harley Bjelland as Editor of SID JOURNAL. Mr. Bjelland is moving from California to Oklahoma.

Mr. Ulbrich is a charter member of the Society for Information Display. He is Publications Chairman and Corporate Secretary of the Society. Previously, he was a Western Regional Director and Chairman of the Los Angeles chapter of SID.

He is currently senior staff engineer with the Advance Product Applications team of McDonnell Douglas Astronautics Co., Huntington Beach, California, in the promotion of the following product lines: air pollution modeling and control systems; audio devices for word recognition, speaker, identification, and audio response; electro-optic devices for communication and computation; telecommunications modeling and demand information systems; biomedical devices for epileptic attack prediction; LNG tanker insulation; and earth resources flight services. Recently has written articles in the areas of predictive displays, demand information systems, minicalculators, and technology growth.

continued to contribute in a very significant manner to the technical advancement of the plasma display technology. In addition, he has been extremely active in the Society for Information Display and the IEEE Display Conferences, contributing time, publications, and a sincere interest in the advancement of display technology."

Activities

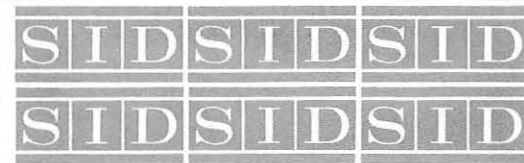

School Lectures By Huntsville SID Members

A five part lecture series was presented to two Huntsville, Alabama High Schools by computer professionals of the local SID Chapter.

This series was presented to Huntsville High School and Virgil I. Grissom High School under the auspices of the Huntsville School Board and the responsible faculty members at each school.

The plan for the lecture series was originated by the local SID Chapter to gain community recognition and experience in presenting SID special interests. To the local educators, it was an exercise to gain experience to aid in implementing a computer curriculum at these schools.

The five part lecture series presented to selected math students consisted of the following topics and speakers:

1. Introduction to Computers—Louis Amis
2. Psychology of Information Display—Bud Johnson
3. Systems Architecture (Hard-

ware)—Stewart Finley

4. Computer Software — Carl Wright

5. Equipment Demonstration — Vince Hoelscher

Mr. Tom Rowan was coordinator for the lectures and provided technical assistance for the demonstration.

The demonstration hardware consisted of a storage tube display terminal connected via acoustic



Members of Huntsville (Ala.) SID chapter review materials used for high school lecture series. From left: Carl Wright, Stewart Finley, Tom Rowan, Louis Amis.



Surprise guest U.S. Senator John Sparkman (D-Ala.) watches equipment demonstration during SID lecture series at

Huntsville (Ala.) high school. From left: Vince Hoelscher, Senator Sparkman, students.

coupler and voice grade lines to a mini-computer located at Marshall Space Flight Center. All equipment was loaned by NASA for the demonstration.

While preparation was challenging, considering the technical expertise of the students, the results were at first baffling, then gratifying. The first four lectures did not invoke any outbursts of enthusiasm, but during the equipment demonstration the light came on. Students found they could do their mathematical home work on an interactive graphics terminal!

At Grissom High School a special three hour session was devoted to the use of the demonstration hardware by approving school personnel.

NOTE: Having recently retired as Social Implications Chairman for SID, having been succeeded by William B. Carson of the Institute of Behavioral Science, University of Colorado, I feel impelled to comment on the great value of this effort of the Huntsville chapter of SID. As it happens, a similar program was proposed to the Los Angeles chapter of SID some two years ago. It foundered, possibly because the membership is thinly spread, geographically, although the membership is more than 300. Perhaps this is the time for projects of social benefit, such as this one of Huntsville's, to be reconsidered by local SID chapters. Those demand information users are out there, waiting—
ERWIN A. ULBRICH, Editor.

From the Membership Chairman

In this day of rising prices everywhere, with the value of the dollar declining in world markets, and the stock market going nowhere (but down), wouldn't you be interested in a real bargain? That's right—a real opportunity to stretch your dollar?

For those of you reading this who are not members of SID, this is your chance. Between July 1 and December 31, you can buy mem-

bership in the only Professional Society dedicated to the multi-disciplined Information Display field for half price. You read it right—50% off the regular price!

What you will buy will be six months of professional affiliation with others of like persuasion and will receive in addition:

1. Regular copies of the SID JOURNAL containing select technical articles of a timely nature plus current news of the Industry and the Society.
2. Quarterly copies of the Proceeding of the SID. The Proceedings contain no advertising and papers are of archival quality. No one serious about the Display business should be without the Proceedings, and they are *ONLY AVAILABLE* at this price through this six-month membership option.
3. All special mailings of SID which are limited to the membership.
4. A chance to decide, with minimum dollar risk, whether or not to become a continuing supporter of SID and help further the science of Display Engineering.

So invest your dollar in the future at a bargain price. Just fill out the Qualification/Membership card bound with this issue, enclose your check for \$7.50, and Vi Puff, of our National Office, will take it from there.

—LOU SEEBERGER
Sid Membership Chairman

L.A. SID Elects

Two new officers were elected for 1973-74 by the Los Angeles Chapter of the Society for Information Display. They are (Chairman) Ted B. Aitken, of Singer-Librascope; and (Secretary-Treasurer) Patricia A. DuPuis, Northrop Corporation.

Gottfried Named

Ira S. Gottfried, CDP, President, Gottfried Consultants, Inc. has been named a member of the Certification Council, governing body for the Certificate in Data Processing (CDP) examination program.

Information Society Panel at ASIS

A feature of the 1973 Annual Conference of the American Society for Information Science (ASIS) will be the professional society panel to be chaired by Mrs. Patricia Powell, Supervisor, Marine Technical Information Center, California Department of Fish and Game, Long Beach, California. The panel will follow the theme of the conference and present "Professional Societies, Their Costs and Benefits." Participants on the panel will represent ASIS, the Special Libraries Association, and the National Microfilm Association, among others. Topics to be covered include the state-of-the-art of the information world, the direction in which the societies are going, the overlap of the objectives of the societies, and the benefits to be derived by being a member of one or a number of the societies interested in information handling.

The panel will treat the subject from the standpoint of the individual as well as from that of the entire professional organization.

The 1973 Annual Conference of the American Society for Informa-

tion Science will be held October 21-25, 1973, in Los Angeles, California, at the Los Angeles Hilton Hotel. Registration and program information can be obtained from the 1973 ASIS Conference Chairman, Mr. H. W. (Bill) Jones, Northrop Corporation, Aircraft Division, Library 3340-32, 3901 W. Broadway, Hawthorne, California 90250, Telephone 213/871-4611, Ext. 1006.

Hawaii Computer Conference Dates

Dates have been set for the 7th Hawaii International Conference on System Sciences, which will be held at the University of Hawaii, January 8-10, 1974. Among topics will be "Computer Nets", and a major feature will be to lay the groundwork for a Pacific Education Computer Network. Information from Western Periodicals Co., 13000 Raymer St., Los Angeles, Cal. 91605.

Information Science Meeting Oct. 21-25

The 36th Annual Meeting of the American Society for Information Science (ASIS) will be held October 21-25, 1973, at the Los Angeles Hilton Hotel in Los Angeles, California.

H. W. (Bill) Jones, ASIS-73 Conference Chairman, has announced that the general theme of this meeting will be "Information: Benefits and Costs," and will feature short, "10-minute" technical papers, formal debates, panel sessions, and Special Interest Group (SIG) activities. Also featured will be exhibitors who will display and demonstrate the latest products of the information industry, including equipment, systems, services, and supplies.

For further information on the ASIS-73 Conference, contact H. W. Jones, Northrop Corporation, Aircraft Division, Hawthorne, California 90250, or Robert McAfee, Jr., ASIS Headquarters, 1140 Connecticut Avenue, N.W., Washington, DC 20036.

Human Factors Invites SID

Members of the Society for Information Display have been invited by A. Carl von Sternberg to membership in the Human Factors Society (HFS). Mr. von Sternberg is chairman of the Membership Committee, HFS. In a letter of invitation, he writes:

"Because of the related, and, in some cases, overlapping interests of our respective professional organizations, it is likely that many of our members would be interested in holding joint membership in both. Pursuant to the interests of the members of your organization who would like to become members of the Human Factors Society, we would like to invite members of the Society for Information Display to join our society."

SID members who are interested are invited to write to Mr. von Sternberg, c/o Essex Corporation, 303 Cameron St., Alexandria, Va. 22314.

NEW PRODUCTS

Tiny New GE SSL-65 Is World Smallest

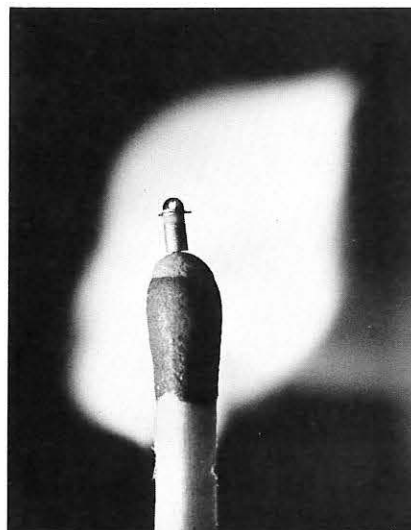

The world's smallest solid state lamp produces invisible light and is dwarfed by the head of a match. Developed by General Electric's Miniature Lamp Products Department, the unique new lamp is the SSL-65, an infrared light-emitting diode only 1/20th of an inch in diameter.

The unit's size will make it useful in applications requiring small center-to-center spacing on printed circuit boards. Such uses include paper tape and retail merchandise price tag readers, and other photo-detection systems.

The 1/20-inch long lamp is the latest addition to GE's IR product line which includes LED's in different sizes and packages ranging in power output from .3 milliwatts for the "pill" package SSL-65 to 7.5 mW for the SSL-55C. The tiny metal and ceramic cylinder is topped by a dome-like glass lens and is extremely rugged and compact.

Circle #101 on Readers Service Card

Xciton Claims Brightest GaP LED

A gallium phosphide (GaP) red light-emitting diode (LED) that is three times as bright as the most efficient gallium arsenide phosphide (GaAsP) backlight is now available in production quantities from Xciton Corp. The XC554-9, believed to be the world's brightest commercial LED lamp, emits 9 millicandela (mcd) at 10 milliamperes (mA).

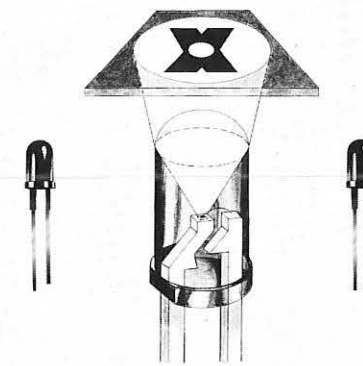

As lead product of a new series, the designator "9" indicates *minimum* mcd rating. Other backlight LED's in the XC554 series are the XC554-6 with a 6 mcd minimum rating and the XC554-3 with a 3 mcd minimum rating. All lamps provide a concentrated 24 degree viewing angle that illuminates a 1/4 inch diameter circle. Each is packaged in a conventional two-pin, red-epoxy-lens housing and is a direct replacement for GaAsP backlighting illuminators.

In addition to filling existing backlight LED sockets, the XC554-9 can replace incandescent and neon lamps in locations where GaAsP backlights are unable to produce sufficient illumination.

Circle #102 on Readers Service Card

Segmented — LED Display

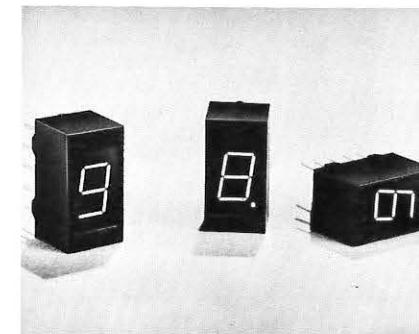

A new compact, highly legible, bright, low power LED readout has been added to Readouts, Inc. display line. *Units are designed and priced for the commercial user.* Overall size .550 x .295 x .335, display size .270 x .160 with 9 degree slant. Uniform light distribution over the entire segment with only one LED per segment.

The units are designed for commercial applications such as computers, panel meters, desk calculators, point of sale equipment, clocks, speedometers and industrial controls.

Circle #103 on Readers Service Card

LED Array Heart of Optical Reader

Spectronics, Dallas based optoelectronics manufacturer, has introduced a new optical reader using an LED Array. The unit operates from a single 5V power source and employs 122 LED's and 122 photodiodes/. The new unit includes a keyboard and is aimed at the point-of-sale terminal market.

Circle #104 on Readers Service Card

LED Drivers

A line of current-limiting LED Drivers has been announced by California manufacturer. Known as the Series 5000, the units directly drive most 7-segment LED displays without external resistors.

Constant current is delivered by the 20-m.A. device if output voltage is maintained above 1.25 Vdc. This permits single or double diode displays to be driven directly.

Circle #105 on Readers Service Card



An LED from IEE

Industrial Electronic Engineers, Inc., announces the availability of LED Displays, featuring the Series 1707 Hexadecimal Display. The Series 1707 is a Solid State Hexadecimal Display with Integral TTL Circuitry to accept store and display 4 Bit Binary Data. Outstanding visibility plus easy system interface are but a few of the features.

0 1 2 3 4 5 6 7 8 9 A B C D E F

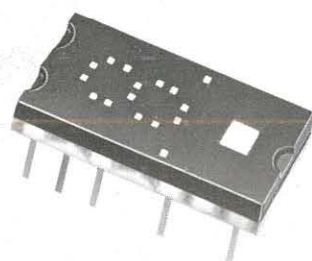

Of major significance is the "natural" formed numbers and letters, critical to Human Factor aspects. Though a Hexadecimal device, this character shape is highly desirable for applications requiring only (0-9) with right or left decimal.

Specifically this LED offers: Complete Hexadecimal Capabilities (0-9 A-F); 0.270-Inch-High (6.858 MM) Character; Separate LED and Logic Power Supply Option; Internal TTL MSI Chip with Latch, Decoder, and Driver; Constant-Current Drive for Hexadecimal Characters.

Circle #106 on Reader Service Card

Pass SID Journal along to a friend.

High Intensity Solid State LED from Litronix

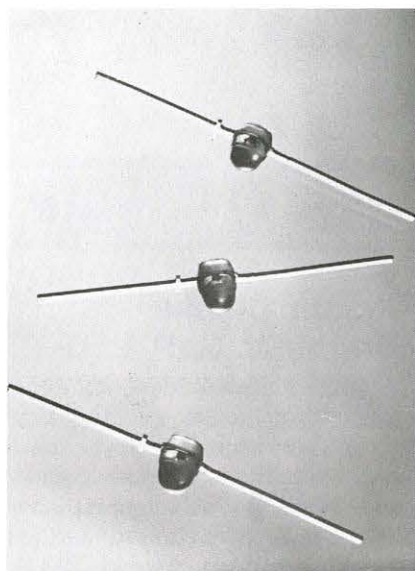

A low current, high intensity solid state LED lamp is being introduced by Litronix. The new RL-55 is a two TTL gate load bright lamp which provides a high on axis intensity of 0.4 mcd at a low 3 mA current. It uses a dark red diffused lens and provides a full .080 inch flooded light with good contrast. A 3 mcd intensity can be achieved if used at 20 mA current.

The RL-55 is designed for diagnostic and circuit status indicator applications or as a function and low voltage indicator on battery powered equipment such as calculators, watches and portable DVMs. Used with low voltage systems, the RL-55 provides an efficient indicator light without causing excessive current drain. The RL-55 operates from a 5V IC logic supply and is designed for minimum linear spacing.

Circle #107 on Readers Service Card

Optical Radiation Measurement System

The Model 740 combines into one compact measurement system—an accurately calibrated spectroradiometer, a broadband radiometer, and a direct reading photometer. The system can be used to measure spectral irradiance over the wavelength range of 300 nm to 1050 nm, radiant power, and illumination. Five sets of slits are

One-Inch CRT From VPI

Video Products, Inc. announces a new area in miniature cathode ray tube technology. 1" O.D. high resolution, small spot size assemblies, complete with deflection yokes and MU-metal shield have been delivered to several customers for use in 3-D helmet type display systems. Operating over a 5 to 10KV range, at a minimum of 850 lines, the CRT is capable of 350 ft-lmbts (P-1 @ 7KV) output from a useful area of 6"x6". All P-1 Phosphors are available. Magnetic deflection enables high resolution applications and spot sizes to .6 mills.



All leads, including the anode lead, exit from the base for streamlined design. The tube weighs only 38 grams and is 5.5" long. The flat face permits simplification of associated optical systems. HI-g shock resistant guns are employed. Sub screen; black screen and fiber optic screens are available.

Priced competitively, units are available F.O.B. Los Angeles. Prototype quantities turnaround is typically 3 to 4 weeks, ARO. Inquiries regarding this unit will be gratefully acknowledged. Production quantities can be provided.

Circle #108 on Readers Service Card

included with a single grating monochromator that produce band-passes of 1, 2, 5, 10, and 20 nm. The system can resolve spectral irradiances as low as 10^{-11} W/cm² nm. Accessories are available for measuring spectral radiance, energy of pulsed sources, and luminance.

Circle #109 on Readers Service Card

LED Photoelectric Control

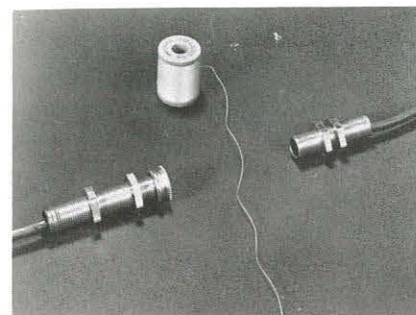

A new modular infra-red LED photoelectric system for the detection and control of objects of any material down to thread size has been introduced by Scientific Technology Inc. Though designed primarily for invisible transmitted beam operation, the STI 7060-series OPTOSWITCH_{tm} also performs exceptionally well as a proximity or retro-reflective sensor. Range is up to 8 feet.

STI 7060-series OPTOSWITCH_{tm} Controls have been field-proved for many sensing, counting and actuating applications where precision is essential. Typical actual production uses already include counting 0.020" diameter drills passing on a conveyor, maintaining a liquid level to ± 0.005 " tolerance, and detecting the presence or absence of a 1/16" thick tabbed lock washer in an assembly. Ambient light and atmospheric deposits of thin films of oil, dust or other environmental contaminants have no effect on the operation of the 7060-series OPTOSWITCH_{tm}. There is never any need to focus, to use external lenses, or to change lamps and detectors.

The 3/8" diameter sensor heads of the STI 7060-series OPTOSWITCH_{tm} are threaded full-length to facilitate mounting in restricted spaces. They may be remotely mounted up to 100' from the control electronics. Complete sealing in epoxy makes them weather and shock proof. Service life is conservatively estimated at more than 25 years.

The all solid state circuitry of the 7060-series OPTOSWITCH_{tm} responds to stimuli at rates as high as 36,000 CPM. A visible LED aids in the simple adjustment of sensitivity and alignment.

Circle #110 on Readers Service Card

New HiNIL 383 Drives LED Displays

A BCD to seven segment decoder for driving LED displays has been added to the Teledyne HiNIL line. The 383 is designed to be compatible with MAN-1 and Data-Lit 10 type displays. A four-bit binary code applied to the data inputs causes the outputs to turn on in the conventional 7-segment code. Since each output of the 383 will sink 20mA, the display can be driven directly without external limiting resistors.

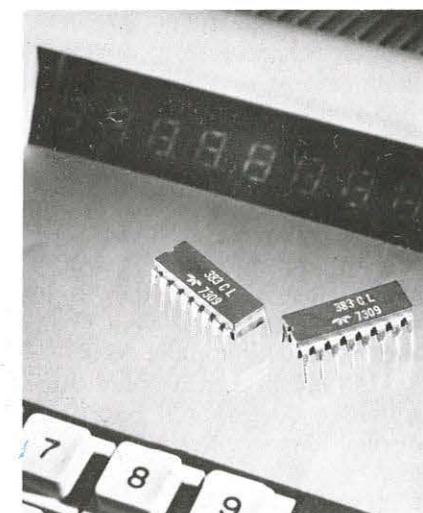

The 383 has a blanking input that turns all of the inputs off whenever it is high (regardless of the state of any other input). A lamp test input is also provided that can be operated whenever the blanking input is high. A logic "O" on the lamp test input will turn all seven inputs on.

Circle #111 on Readers Service Card

LEF Engineering Samples

Sample displays with .35-inch digits are available in arrays containing from three to 17.5 digits.

Standard .35-inch samples with six digits or less are supplied complete with battery-powered drive electronics as required to light the entire display. Segment selection is not provided. Standard .35-inch samples containing seven or more digits are supplied with an appropriate number of excitation circuits for driving the display.

LEF engineering samples are priced at \$20.00 per digit.

Circle #112 on Readers Service Card



New CRT Magnetic Shields

Ad-Vance Magnetics, Inc. was given the triple problem of shielding the neck portion of the CRT from local magnetic fields, providing adequate structural support for the tube, and keeping the cost lower than for the usual CRT shield. Cost was a factor due to the large number of shields required.



The solution lay in properly combining magnetic and non-magnetic materials. A cylindrical element of .020 AD-MU-78 was used to shield the magnetically critical neck area. By experiment, it was determined that this provided all the shielding required for good resolution. A thickness was selected which would provide a safety factor against saturation.

Circle #113 on Reader Service Card

HUMAN ENGINEERING GUIDE TO EQUIPMENT DESIGN—A New and Revised Edition Edited by Harold P. Van Cott and Robert G. Kinkade - Published by the Government Printing Office - Clothbound \$8.00.

This excellent handbook, sponsored by the Joint Army-Navy Air Force Steering Committee, expands the 1963 edition. The work of many specialists in Human Engineering has been well organized and edited into this massive 760 page volume.

As for its contents, here are the chapter titles:

1. System And Human Engineering Analyses
2. Man As A System Component
3. Visual Presentation Of Information
4. Auditory And Other Sensory Forms Of Information Presentation
5. Speech Communication
6. Man-Machine Dynamics

7. Data Entry Devices and Procedures
8. Design Of Controls
9. Design Of Individual Workplaces
10. Design Of Multi-Man-Machine Work Areas
11. Engineering Anthropology
12. Designing For Maintainability
13. Training System Design
14. Training Device Design
15. Human Engineering Tests And Evaluation

Each chapter has a lengthy bibliography to support and provide details for the chapter topic.

One comment the author of future editions should keep in mind: to the best of the reviewer's knowledge, none of the authors are from private industry. Surely private industry does most of the "Equipment Design" to which Human Engineering is applied.

This comprehensive and useful reference book should be in every display engineer's and human factors specialist's library. Besides, who can pass up a bargain like 760 pages for only \$8.00?

Order from:

Superintendent of Documents
Government Printing Office
Washington, D. C. 20402

Human Engineering Guide to
Equipment Design \$8.00 per
copy.

Catalog No. D210.6/2:En3, Stock
No. 0851-0050

October Software Mission to Brazil Planned by DOC

A dozen American firms in the Computer Software and Services Industries are being invited to participate in an official U. S. Trade Mission to Brazil, Oct. 8-19, 1973 by the U. S. Department of Commerce. This sales promotion effort is scheduled to take advantage of "unprecedented demand" in this market and the Brazilian National Data Processing Congress held in Rio from Oct. 14-19, 1973.

Although Brazilian computer center establishments are increas-

ing in number and are beginning to develop programs and systems of their own, the country's lack of adequately trained personnel in this area suggests a growth in software/services sales to Brazil matching sales in the hardware field through 1980. Thereafter the growth of the software/services market will depend in great part on the software/services exporters' ability to tailor their applications much more specifically to local needs, to reduce prices moderately (possibly through expanded sales in Latin America) and to upgrade the quality and responsiveness of their maintenance/servicing programs.

An estimated \$200 million in equipment, software services and related operations is now being spent by Brazil each year. Average increases in world exports (units) to Brazil of computer hardware since 1967 have exceeded 30 percent annually. This trend is expected to continue through 1977 with sales to Brazil of software and services growing at a corresponding rate.

The appropriateness of a trade mission to Brazil in this field now is enhanced by concurrent Brazilian Government efforts to encourage economies in the use of existing equipment and complementation considerations in the purchase of new equipment. The Government is moving to establish (1) inter-agency Government computer centers, (2) joint government-industry computer use advisement groups and (3) selectivity in tariff exemptions favoring equipment that could improve utilization of existing national capacity. The US computer software companies have a role to play in these efforts by Brazil principally by providing what the Brazilian computer user needs and making sure that the Brazilian is at all times fully aware of the range of services his firm offers.

An official U. S. Trade Mission Business Information Center will be set up at the Brazilian' National Data Processing Congress. This week long event organized by the Brazilian Computer Users Association (SUCESU) will bring together the most important deci-

turn to page 30

SID Welcomes The Following New Members

Sidney A. Aipert, University Patents, Inc., Stamford, Cn.; James K. Amster, NASA, Merritt Island, Fl.; Euval S. Barrekette, IBM, Yorktown Hgts, New York; Robert L. Basford, Bell Laboratories, Holmdel, N.J.; Charles J. Beatty, Singer Corp., Binghamton, N.Y.; James D. Benham, ITT, Roanoke, Va.; Delmorris Blakely, Northrop Corporation, Hawthorne, Ca.; Ulrich Bonne, Honeywell, Inc., Bloomington, Mn.; Robert A. Breckenridge, NASA, Newport News, Va.; Thomas P. Brody, Westinghouse, Pittsburgh, Pa.; W. Marvin Bunker, General Electric Co., Ormond Beach, Fl.; D. D. Bursch, IBM, Vestal, N.Y.; David J. Buscher, Harry Diamond Labs., Silver Spring, Md.; Mark E. Carpenter, GTE Sylvania, Seneca Falls, N.Y.; Carmen A. Catanese, RCA Labs., Rocky Hill, N.J.; John J. Chapps, The Maryland Institute, Baltimore, Md.; Wade E. Clarke, Systems Engineering, Washington, D.C.; Hershel E. Clauder, TRW, Inc., Houston, Tx.; William M. Coderre, Bell Northern Research, Ottawa, Ontario, Canada; Thomas L. Credelle, RCA Corp., East Windsor, N.J.; Tony N. Criscimagna, IBM, Kingston, N.Y.; Brian Dale, GTE Labs., Lynnfield, Mass.; Gene F. Day, Varian Assoc., Palo Alto, Ca.; Ronald C. Derby, California Computer Products, Anaheim, Ca.; Joseph E. Diamond, Loral Electronic Systems, Monsey, N.Y.; Gilles J.G. Dionne, Loretteville, Quebec, Canada; Ralph L. Dodds, Visualtek, Santa Monica, Ca.; Brian Ellis, Royal Aircraft Est., Farborough, Hampshire, England; Robert J. Eneedy, Sperry Univac, St. Paul, Mn.; Edwin W. Engberg, Ampex Co., San Carlos, Ca.; Rudolf Engelbrecht, RCA Labs., Switzerland;

Chester M. Fackler, Jr., IBM, Austin, Tx.; David P. Fahy, St. Louis, Mo.; Saul S. Fathi, SCM Corp., Huntington, L.I., N.Y.; Charles A. Fenwick, Collins Radio Co., Cedar Rapids, Iowa; John B. Flannery, Jr., Xerox Corp., Webster, N.Y.; Shigemasa, Furvuchi, Asahi Glass Co., Yokohoma, Japan; Tom E. Godfrey, Northrop Corp., Hawthorne, Ca.; John E. Gould, Sperry Univa, Minneapolis, Mn.;

Hayes R. Groo, III, CBS Labs., Wilton, Cn.; Hans J. Gross, West Germany; Donald M. Haadsma, Lear Siegler, Inc., Grand Rapids, Mi.; John J. Hall, IBM Watson Research Center, Yorktown Hts., N.Y.; Hannu K. Hannukainen, Finland; Clifford C. Harris, Honeywell Information Systems, Reading, Mass.; Donald J. Heller, General Electric Co., Pittsfield, Mass.; T. Theodore Highley, Jr., Leeds & Northrop Co., Glenside, Pa.; M. Hoffman, France; Paul D. Holzschuher, Industrial Nucleonics, Columbus, Oh.; Robert C. Howard, Aerojet Electrosystems, Azusa, Ca.; Robert W. Howard, AIL, N. Babylon, N.Y.; Alexander D. Jacobson, Hughes Research Labs., Malibu, Ca.; Richard N. Jamieson, Jamieson & Assoc., Minneapolis, Mn.; Les A. Jeffries, Northrop Corp., Palos Verdes, Ca.; Sam S. Jobs, General Electric Co., Vestal, N.Y.; R. David Keillor, IBM, Rochester, Mn.; David L. Keune, Monsanto Co., St. Louis, Mo.; Ray S. Kicklighter, Eastman Kodak, Rochester, N.Y.; Steven G. Kitchen, Bohn Rex-Rotary, Englewood, N.J.; Richard I. Klein, Liquid Crystal, Inc., Edison, N.J.; Tavorath K. Lakshmanan, Robertson & Assoc., Matawan, N.J.; George H. Lane, McDonnell Douglas Corp., St. Louis, Mo.; King K. Lee, Sperry Systems, New York, N.Y.; Marshall Leibowitz, Timex Corp., Englewood, N.J.; Wesley E. Lerdon, Industrial Nucleonics, Columbus, Oh.; Edwin Levin, Bell Labs, New Brunswick, N.J.; John W. Lewis, Yale University, New Haven, Ct.; John R. Longland, Sanders Assoc., Nashua, N.H.; Andre J. Louineau, Rennes, France; Richard J. Lukso, Jet Electronics & Technology, Grand Rapids, Mi.; John P. Lyons, Wright Patterson AFB, Dayton, Oh.; Michael J. McGovern, Bunker-Ramo, Thousand Oaks, Ca.; Michael P. McKenna, Ministry of Transport, Ottawa, Ontario, Canada; Milton K. Massey, RCA Crop., Lancaster, Pa.; Richard W. Midland, General Time Corp., Rolling Meadows, Il.; Carl Milner, Algorex Data Corp., Syosset, N.Y.; Charles W. Mitchell, Jr., Xerox Corp., Webster, N.Y.; William T. Moore, Rank Research Labs., Middlesex, Eng-

land; William G. Mulley, Naval Air Dev. Center, Warminster, Pa.; Perry L. Nelson, RCA Laboratories, Tarzana, Ca.; Barry A. Nolan, Van Der Veer Photo Effects Co., Saugus, Ca.; Eugene M. Orosz, IBM Corp., Poughkeepsie, N.Y.; Vincent C. Oxley, GTE Laboratories, Waltham, Ma.; Marcel A. Pahlavan, Datamatics, Los Angeles, Ca.; P. Andrew Penz, Texas Instruments, Richardson, Tx.; Petros T. Petrides, General Dynamics, Stonington, Cn.; Daniel J. Provine, Westinghouse Electric Corp., Baltimore, Md.; Peter P. Pungitore, Times Industries, Ramsey, N.J.;

David M. Reed, ANPA Research Institute, Easton, Pa.; Marya G. Repko, The Hague, Holland; Roland W. Rhodes, RCA, Indianapolis, In.; Gordon J. Ritchie, University of Essex, Essex, England; James E. Roberts, Vector General, Canoga Park, Ca.; Donald K. Robbins, Sandin Labs., Albuquerque, N.M.; Thomas L. Robinson, Astronics Corp., East Aurora, N.Y.; Robert J. Salem, General Electric Co., Bridgeport, Cn.; Donald L. Say, Sylvania Electric, Inc., Seneca Falls, N.Y.; John A. Schafer, Teleprocessing Ind., Inc., Saddle River, N.J.; Jerry D. Schermerhorn, Owens-Illinois, Swanton, Oh.; Jacob H. Schwartz, Loral Electronics Systems, The Bronx, N.Y.; John H. Selander, Mitre Corp., McLean, Va.; Charles A. Selzo, IBM Corp., Kingston, N.Y.; Shigeo Shima, Sony Corp., Yokohama, Japan; John L. Simonds, Eastman Kodak Co., Rochester, N.Y.; Richard L. Skovholt, General Electric Co., Wilmington, Ma.; Stephen A. Smithson, Sperry Information Displays, Scottsdale, Az.; Hans O. Sorensen, Hewlett-Packard, Palo Alto, Ca.; David A. Springer, NASA, Titusville, Fl.; John F. Stalma, IBM, Owego, N.Y.; Robert L. Stettiner, Hewlett-Packard, Lexington, Mass.; Kent A. Stevens, National Institute of Health, Bethesda, Md.; Arthur J. Stock, Acheson Colloids Co., Port Huron, Mi.; Gene G. Take-mura, Hitachi Ltd., Chicago, Il.; Lawrence C. Tarbell, Jr., Department of Defense, College Park, Md.; Daniel E. Thornhill, Adage, Inc., Boston, Ma.; John R. Trimmer, Advanced Technology Center, Inc., Arlington, Tx.; Ichiro

turn to page 30

Letters

Amplification

Gentlemen:

I would like to comment on the definition (Glossary of Terms, SID Journal, Nov/Dec, 1972, p. 18) of deflection defocusing because I have found some confusion exists in distinguishing this effect from that due to a change in image distance when one is using a flat faced CRT. May I suggest that a note be added to the definition and possibly the wording altered slightly to cover this point. My suggestion is:

Deflection defocusing: An enlargement (usually nonuniform) of the spot caused by focusing action on the beam when deflected.

Note: A flat faced or long radius CRT will exhibit enlargement of the spot when deflected due to an increase in image distance alone. This effect is independent of deflection defocusing which will occur at the same time. Focusing modulation is often employed to compensate for the increase in image distance.

F. JOHN MARSHALL
Chief Engineer
Electro-Optical Devices
Litton Industries
Electron Tube Div.
San Carlos, Cal.

Tsunodo, Tokai University, Kawasaki, Japan; Paul T. Tucker, University of Illinois, Urbana, IL; John F. Turner, Rockwell International, Los Angeles, Ca.; Alex. Van Tongerlo, Bowmar Canada, Ltd., Ottawa, Ontario, Canada; Russell Varcoe, Information Mgt., International, New York, N.Y.; Franco Vincentini, Selenia SPA, Roma, Italy; Stuart M. Walker, Ontario Hydro, King City, Ontario, Canada; Marshall Watnick, Norden Div. of UAC, Trumbull, Cn.; Geoffrey P. Watts, Sperry-Rand, Tempe, Az.; Tony R. White, University of Florida, Gainesville, Fl.; Lenard M. Wintfeld, Monroe Calculator, Jackson Mts., N.Y.; Horst Witzke, Optel Corp., Princeton, N.J.; Yiu Kwan Wo, Bell Labs., Scotch Plains, N.J.; Joseph J. Wysocki, Xerox Corporation, Rochester, N.Y.; John M. Xines, Computing Devices of Canada, Ltd., Ottawa, Canada; Robert A. Young, American Microsystems, San Jose, Ca.

If You Heard 'Em Lucky, If You Didn't, Too Bad

To advise SID members the variety and types of programs being made available to members of SID chapters, here is a selection from recent chapter meetings. If you didn't attend, look what you missed:

SAN DIEGO CHAPTER

May 22, 1973

Speaker: Herbert C. Hendrickson, Philco-Ford WDL.

Subject: Digital TV—Generation and Display of Graphic Images on a CRT with Fixed Raster Formats.

June 28, 1973

Speaker: Lee Harrison, Computer Image Corporation.

Subject: New interface between user's digital input source and CAESAR, fully integrated character animated display system.

LOS ANGELES CHAPTER

May 30, 1973

Subject: Visit to Honeywell Marine Systems Division, to view highspeed interactive display system for flicker-free performance, and demanding high-density data.

June 19, 1973

Speaker: Pierce Siglin, SID member.

Subject: Demonstration of large-screen laser-photochromic film display system.

(SAN FRANCISCO) BAY AREA CHAPTER

April 26, 1973

Speakers: Bill Scharrenberg, Pete Kantmann of Ramtek

Subject: Color Graphic Display Systems.

May 24, 1973

Subject: The Chapter's "Spring Thing" was held at the Weibel winery's Champagne Cellars. Activity included installation of officers and social evening with dinner.

SID Sustaining Members

ALLGEMEINE ELEKTRICITÄTS—GESELLSCHAFT

AEG-Telefunken
Vorstandssekretariat
6 Frankfurt/Main-Sud
West Germany
AEG Hochhaus

BURROUGHS CORPORATION

Defense, Space & Special Systems Group

Paoli, Pennsylvania

CONRAC CORPORATION

330 Madison Avenue
New York, New York 10017
SIEMENS AG

DuMONT ELECTRON TUBES DIVISION

Clifton, New Jersey

FERRANTI ELECTRIC COMPANY

Plainview, New York

GML CORPORATION

594 Marrett Road
Lexington, Massachusetts 02173

HUGHES AIRCRAFT COMPANY

Culver City, California 90230

IBM CORPORATION

Armonk, New York

PHOTO RESEARCH DIVISION

KOLLMORGEN CORPORATION

3000 N. Hollywood Way
Burbank, California 91505

NAC INCORPORATED

7-1 Ginzanishi
Chuo-Ku, Tokyo, Japan

PHILCO-FORD CORPORATION

Palo Alto, California

ELECTRONIC SYSTEMS DIVISION

RANK PRECISION INDUSTRIES LTD.

Sidecup-by-Pass
Sidecup, Kent, England

SIEMENS AG

Tubes Division
76 St. Martinstr
Munich, West Germany

SINGER-LIBRASCOPE

Aerospace & Marine Systems Group
808 Western Avenue
Glendale, California 91201

SYNTRONIC INSTRUMENTS, INC.

100 Industrial Road
Addison, Illinois

TEKTRONIX, INC.

Information Display Products
P.O. Box 500
Beaverton, Oregon 97005

THOMAS ELECTRONICS, INC.

100 Riverview Drive
Wayne, New Jersey 07470

THOMSON-CSF

Paris, France

DEPARTMENT OF SUPPLY

WEAPONS RESEARCH
ESTABLISHMENT
Salisbury, South Australia 5108

XEROX DATA SYSTEMS

El Segundo, California 90245

Software Mission

continued from page 28

sion makers of Brazil. Prior to that, Trade Mission members will be introduced to businessmen and government officials in Sao Paulo and Brazilia under the most favorable circumstances.

You are invited to call Mr. Fred Crosley in Washington at the Commerce Department — Tel: (202) 967-2973. There is no charge.

Advertisers Index

Institute of Electrical & Electronics Engineers	13
Lumiscop	20
Optical Coating Laboratory, Inc.	31
Photo Research Corporation	4
RCA Electronic Components	32
Special Purpose Technology Co.	10
Syntronic Instruments	2



OCLI Antireflection Coatings Improve the View...nearly everywhere.

It all started with a need to reduce the glare from aircraft instrument covers. Working closely with the U.S. Air Force, OCLI designed and developed a multilayer state-of-the-art coating that reduced reflections five times better than a single layer of MgF₂. For several years now pilots have been able to read their instruments with ease through covers

coated by OCLI and our licensees. A most satisfying development, but that was only the beginning. Today descendants of that coating, each modified to do a specific job, are improving the view in a lot of places.

If you are having trouble with reflections, ghost images, poor visibility, we can probably help you. If yours is a stubborn problem and you

let us in at the beginning, chances are you'll benefit from working with our research scientists and design engineers. Try us. We supply more than just a product.

OCLI OPTICAL COATING LABORATORY, INC.

Technical Products Division
2789 Giffen Ave., P.O. Box 1599, Santa Rosa, CA 95403
Teletype 510-744-2083. Telephone 707-545-6440.

Manufacturing facilities serving Europe, OCLI Optical Coatings, Ltd., Dunfermline, Fife, Scotland / Represented in Japan by Hakuto Co., Ltd., Tokyo; France, Belgium, Netherlands and Luxembourg by Techmaton of Paris, Brussels & Amsterdam; and in Germany, Austria, Switzerland and Italy by Betzelt GMBH, Munich.